







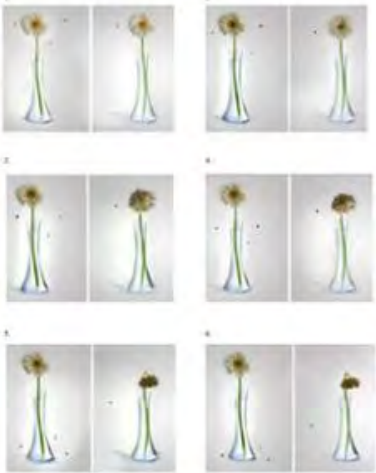

Bewegungsmarken / Motion Marks

Land Country	Aktenz. Serial#	Marke Mark	Klasse Class	Anmelder Applicant	Status*	Check
AU	848112	 <p>The trade mark consists of a moving image showing a black bordered yellow coloured square with rounded corners. The letters Y, E, L, L appear individually and sequentially in the square. The representation on the application form shows the eight stills that make up the sequence.</p>	9 16 35 36 37 38 39 41 42	Yell Ltd	R	2002
AU	1214652	 <p>The applicant advises that the trade mark consists of an animated sequence of images as shown in the attachment to the application form. The animated sequence starts with an infinity symbol travelling away from the viewer, which is then quickly transformed into a stylised form of the word HISAMITSU while a series of vertical blue bars originating in the infinity symbol move quickly both to the right and to the left of the infinity symbol. During this sequence, in the background, a larger infinity symbol moves and fades away. A two dimensional representation of scenes from the animated sequence is also included in the application form.</p>	5	Hisamitsu Pharmaceutical	R	2009
AU	1286661	<p>The applicant has advised that the trade mark is a moving image beginning with a bright light diffusing from the centre of the screen, followed by the whole screen being covered with two coloured lights that are sparkling in BLUE and YELLOW, with the words SONY MAKE.BELIEVE appearing afterwards and concluding with two lights</p>	9 28 35 37 38 41 42 45	Sony Corp	R	2010

		focusing on the dot in the middle as shown in the attached video image.				
AU	1380532	 <p>The trade mark is a movement mark. It consists of the image of two flowers in vases side by side, with flies flying around them. The left flower remains bright, healthy and largely unchanged, except that the flies around it eventually appears dead or dying, however the flower on the right progressively droops, wilts and discolours until it eventually appears dead and the fly near it remains alive. The trade mark appears in the video clip attached to the application.</p>	5 9 21	Reckitt Benckiser AU	R	2012
AU	1472463	 <p>The trade mark is a movement mark as shown in the representation attached to the application form. It consists of a boy leaping into the air</p>	12	Toyota Motor Corp	R	2015

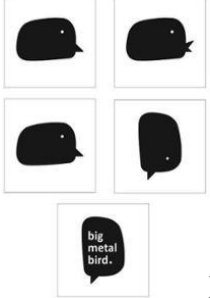
		from a standing start extending his arms and legs out to his sides at the same time while in mid air and forming a star shape. The image attached to the application form is a still of a scene from the video clip.				
AU	1490804	 <p>The mark is an animated SEQUENCE OF CUBE EXPLODES WITH BALLOON SHAPED OBJECTS & MOUTH OPENS WITH WORDS</p>	35 38 41	OOH! Merdia operation	R	2012
AU	1526407	The trade mark is a movement mark. It consists of the words UNDERSTAND INSURANCE next to a thought cloud. It pauses for one second on each of the following animated cartoons, in order; car, calculator, briefcase, boat, motorcycle, two ears of grain, spanner and hammer, broken glass, storm cloud, tennis ball and racquet, person and staircase, aeroplane, paw print, computer, suitcase, keys, house, gauge, fire, question mark, house, lounge, telephone, caravan, car, calculator and briefcase. The trade mark appears in the video file attached to the application form.	16 35 36	Insurance Council of Australia	R	2013



AU	1562342	 <p>ANIMATED SEQUENCE WITH LTR M & DISCS FORM 2 DISC-HEADS KISSING, CHILD VOICE UTTERING WORDS "MAMY POKO" & A KISS</p>	5	Uni-Charm Corp	E R	2014
AU	1605835	<p>The Trade Mark is a movement mark. The trademark is an animated sequence consisting of a moving/flowing spirograph composed of a series of lines as shown in the accompanying MP4 file. The Trade Mark appears in the video file attached to the application form</p>	9 36	IG GRoup	E W	2015
AU	1720609		9	Seagate Technology LLC	E W	2017
AU	1756274	 <p>Mark Description: The mark consists of a motion mark; the mark transitions from a bird-like image</p>	41	United Airlines	R	2016



		with its beak closed (fig. 1 top left) to a bird-like image moving its beak open (fig 2 top right) and closed (fig. 3 middle left) with the image then rotating clockwise into a speech or thought bubble image shaped like an airplane passenger window (fig. 4 middle right) into which the words "big metal bird" appear in sequence from top to bottom with a "." appearing after "bird" (fig. 5 bottom middle); the squares are not part of the mark but used only to separate the freeze frames showing various points of movement.				
AU	1784550	The Trade Mark is a Movement mark. The mark consists of an animation of a swarm of dots that circle and move to create a designed splash of ink with a stylized letter "M" at the center. The Trade Mark appears in the video file attached to the application form.	9 35 38 41 42 45	Meetup Inc	R	2017
AU	1792596	 <p>The mark consists of a motion mark in color. The nature of the motion is that of the word "Google" appearing from left to right, by letter, respectively in BLUE, RED, YELLOW, BLUE, GREEN and RED which dissolves into four small solid colored circles of, from left to right, BLUE, RED, YELLOW and GREEN which slightly undulate then dissolve into four short vertical lines of differing lengths which are, from left to right, BLUE, RED, YELLOW and GREEN, forming the image of an equalizer. The vertical lines dissolve back into four small solid colored circles of, from left to right, BLUE, RED, YELLOW and GREEN</p>	9 35 39 41 42 43 45	Google LLC	R	2017

		which sharply bounce and come to a rest, ending the animation. The trade mark appears in the video clip attached to the application.				
AU	1802602	 <p>The trade mark consists of a visual representation of a three dimensional character in the form of a man in static pose as shown in the still images attached to the application form and in animation as shown in the video clip attached to the application form. The two dimensional images of the man attached to the application form are stills from the video clip. The trade mark does not include words or sound.</p>	9 16 35 41	Transport Accidental	R	2018
AU	1813005	The mark consists of a composite motion and sound mark depicting a television screen with the words "THIS HAS BEEN A PRESENTATION OF HOME BOX OFFICE" in sharp lettering which fades to a smaller screen of static "snow" with the wording fading and then the static snow screen "clicks off" as in the turning off of a television set. Simultaneously with the fading out and "clicking off" portion of the visual component, the sound element is the sound of a choir-like bass chord resolving to the sound of static and	41	Home Box Office	R	2017

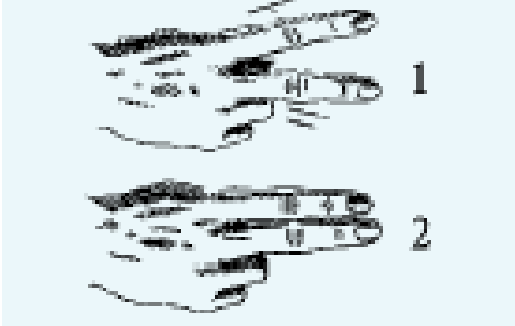

		then to a "click" sound as in the turning off of a television set. The Trade Mark appears in the video file attached to the application form.				
AU	1817605	The Trade Mark is a movement mark. It consists of a ribboned box, which opens at the top to partially reveal a cartoon-like face, specifically its eyes which move from left to right and then to the centre. The cartoon-like face then drops back into the box. The Trade Mark appears in the video file attached to the application form.	9 35 36 42	Naamtech technologies	R	2017
AU	1840549	The Trade Mark is a movement mark. It consists of a man wearing sunglasses and a black waistcoat over a white T-shirt with his right hand holding grains of salt. The man raises his arm and opens his hand to release the grains of salt so that they are sprinkled onto a piece of meat on a table or bench below. The Trade Mark appears in the video file attached to the application form.	25 39 43	D ET VE ET URUNLERI GIDA	R	2019
AU	1852210	The Trade Mark is a moving image. The moving image is of a person holding a rope. The rope is attached to a motorcycle which drags the person. The Trade Mark appears in the video file attached to the application form	25	Becon Pty	R	2018
AU	1862843	The applicant has advised that the gesture displayed in the video is the AUSLAN letters A-T-E appearing in the trade mark as a movement mark	9 16 36 41 44	Innofy Pty	R	2018
AU	1874376	The Trade Mark is a visual representation of letters creating a word as shown in the video file attached to the application form. The Trade Mark appears in the video file attached to the application form	20	Bedshed franchising	R	2019
AU	1874430	The Trade Mark is a movement mark being a 2-dimensional depiction of a humanoid face that changes from a neutral expression to various other expressions as shown in the video file, including happy, sad, optimistic, and blinking, depending on the interaction with the user of the services. The Trade Mark appears in the video file attached to the	45	Evorce Pty	R	2018

		application form				
AU	1882475	The Trade Mark is a pulsing ring which illustrates the interaction around a specific location. The Trade Mark appears in the video file attached to the application form.	35 41	IP (TAS) Pty	E	2019
AU	1886024	 <p>The mark consists of a motion mark incorporating sound. The mark begins with a single ORANGE and a BLUE triangle that then rotate and duplicate until there are multiple triangles that blend together to form a stylized "S" comprised of two triangles and two polygons. The word "SATORI" in BLUE fades in from the right, directly under the stylized "S". As this is happening, these musical notes are being played as an ascending arpeggio on a synthesizer using bell tones: (16th notes) C3, G3, A3, C4, G4, C5, C5, G5, C6, followed by these musical notes being played using a Tibetan bell: (16th notes) G5, C6.; Mark Description: The mark consists of a motion mark incorporating sound. The mark begins with a single ORANGE and a BLUE triangle that then rotate and duplicate until there are multiple triangles that blend together to form a stylized "S" comprised of two triangles and two</p>	42	Satori worldwide	R	2018
AU	1909357	The Trade Mark is a movement mark. It consists of scattered white dots whirling in a changing pattern on an orange background. The Trade Mark appears in the video file attached to the application form.	35	Nous Group PTY	R	2018
AU	1914384	The Trade Mark is a Movement mark. The mark consists of the animation of a vehicle driving along a road formed from the extension of the leg of the letter X in the word EXTERRAIN. The Trade Mark appears in the video file attached to the application form	35	Exterrain Pty	R	2018
AU	1935737	The Trade Mark appears in the video file attached to the application form. The trade mark is a movement mark. The	36	Citigroup	R	2018

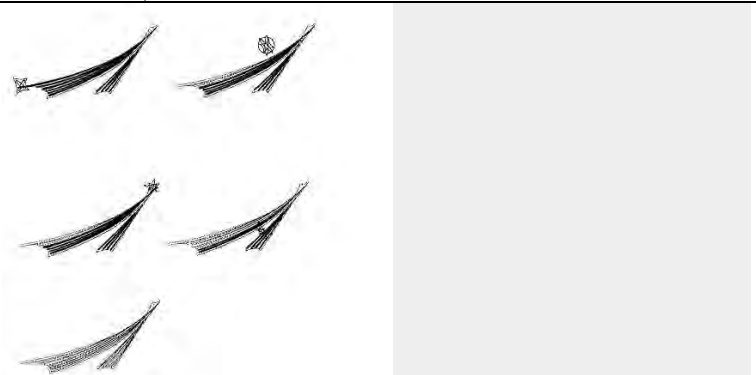
		mark consists of a motion where a LIGHT BLUE rectangle immediately followed by a DARK BLUE square appears to rise along a horizontal axis and together form a row. Then, three BLUE rectangles of varying heights and shading move and expand from right to left, so that they are positioned in ascending order above the row comprised of the LIGHTER BLUE rectangle and DARK BLUE square. The trade mark appears in the video file attached to the application form. The individual frames of the movement mark appear in the document attached to the application form..				
AU	1939995	The trade mark is a movement trade mark that consists of the word EVERSEEN surrounded by an oscillating circle composed of dots and lines. The trade mark is as represented in the video file attached to the application form.	9 42	Everseen Ltd	R	2019
BX	520574	 <p>(über Verkehrsdurchsetzung)</p>	30	Mars B.V.	R	2002
CH	495047	 <p>Bewegungsmarke: die Farbe verändert sich in den Wellen kontinuierlich von rot in grün in der Richtung von unten links nach oben rechts und innerhalb einer Zeitspanne von 8 Sekunden</p>	5	Bayer Consumer Care AG	R	2002

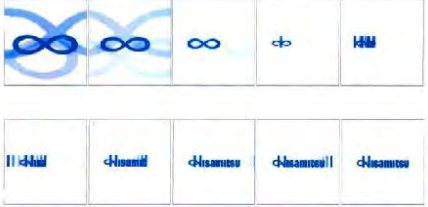
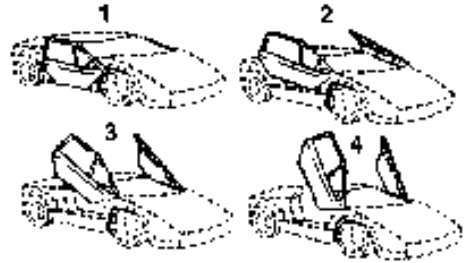
CH	598363	 <p data-bbox="474 352 1240 496"><i>Trademark with movement: The circle appears, the lines become clearer and a circle, completely visible, takes form, which then disappears again (flashing circle; duration: 3-4 seconds).</i></p>	10	Hamilton Medical AG	R	2010
CH	598773	 <p data-bbox="474 719 1261 831">Trademark with movement: The three blue lines turn continuously towards the left (1 turn: duration approximately 12 seconds).</p>	10	Hamilton Medical AG	R	2010
CO	403526	 <p data-bbox="474 1206 1252 1366">LA MARCA ES UNA SECUENCIA ANIMADA CON DOS SEGMENTOS DE DESTELLOS QUE SE UNEN EN LA PORCIÓN SUPERIOR DERECHA DE LA MARCA. DURANTE LA SECUENCIA DE ANIMACIÓN, UN OBJETO GEOMÉTRICO SE MUEVE DE MANERA ASCENDENTE Y ADYACENTE AL PRIMER SEGMENTO Y LUEGO EN FORMA DESCENDIENTE Y ADYACENTE AL SEGUNDO</p>	9	Microsoft Corp	R	2010

		SEGMENTO MIENTRAS QUE LAS CUERDAS INDIVIDUALES DE CADA SEGMENTO SE TORNAN DE OSCURO A CLARO. EL PUNTEADO QUE SE MUESTRA EN LA MARCA ES PARA MOSTRAR EL SOMBREADO. NO SE REIVINDICA COLOR COMO PARTE DE LA MARCA				
CO	512639		5	HISAMITSU PHARMACEUTICAL CO., INC	R	2015
DE	39942129		12 28	Automobili Lamborghini	E A W	2004

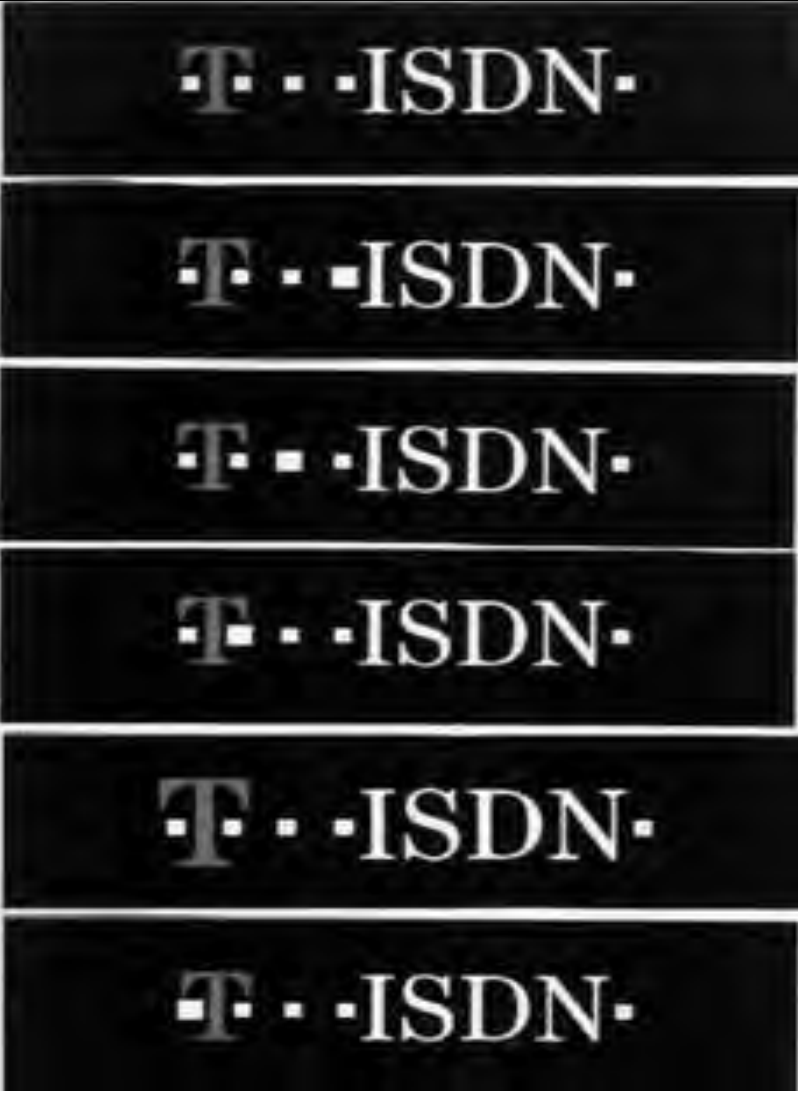

DE	30157686		3 16 21	Henkel KGaA	R	2002
DE	30166489		41 42	Laufend Fit GmbH	R	2002

DE	30209487	 <p data-bbox="479 1251 1274 1358">Die Marke betrifft die Zeichenfolge nach Zeile 1, bei der der Buchstabe T und eines der Quadrate rhythmisch linear von rechts nach links vergrößert werden.</p>	9 16 38 42	Deutsche Telekom AG	R	2004
----	----------	---	---------------	---------------------	---	------

DE	30209488		9 16 38 42	Deutsche Telekom AG	R	2004
----	----------	--	---------------	---------------------	---	------

DE	30305188		1 3 5	Henkel KG aA	R	2003
DE	30305189		3	Henkel KGaA	R	2003

DE	30305190		3	Henkel KG aA	R	2003
DE	30305191		1 3 5	Henkel KG aA	R	2003

DE	30313906		1 3 5	Henkel KG aA	R	2003
DE	30313907		1 3 5	Henkel KG aA	R	2003

DE	30339724		9	Nec Corporation	R	2005
DE	30423378		30 35 43	Colours economic communications GmbH	R	2004

DE	30515594	 <p>blau, silber, gelb, rot, grün, schwarz, weiß</p>	1 2 3	Reckitt Benckiser	R	2005
DE	30550694	 <p>blau, rot, rosa, weiß, grau, braun</p>	3 5 21	Henkel KG aA	R	2006

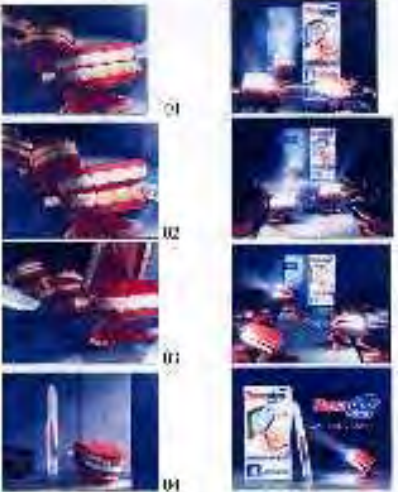
DE	30550695	 <p data-bbox="884 635 1263 699">08 rot, rosa, beige, braun, blau, grau, schwarz, weiß</p>	3 5 21	Henkel KG aA	R	2005
DE	30550697		3 5 21	Henkel KG aA	R	2005

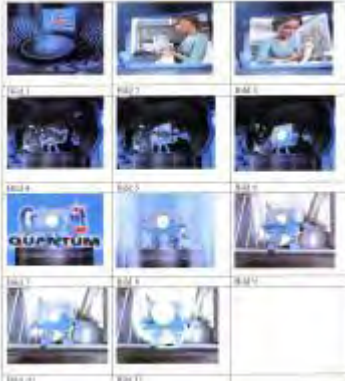

DE	30600891	 <p data-bbox="472 526 1261 1035">Bewegungsmarke, namentlich die Darstellung einer Folge von bewegten Bildern. Die Marke zeigt die graphische Darstellung in verschiedenen Perspektiven von einer, sich bewegenden Geschirrspültablette. Bei der Marke handelt es sich um den Bewegungsablauf von elf Bildern (Darstellung 1 bis Darstellung 11 gemäß graphischer Wiedergabe), wobei diese in aufsteigender Reihenfolge ohne dazwischen liegende Pause gezeigt werden. Die einzelnen, in Bild 1 bis Bild 11 gezeigten Darstellungen, werden für folgende Zeitdauer gezeigt: Bild 1 2 Sekunden; Bild 2 2 Sekunden; Bild 3 2 Sekunden; Bild 4 2 Sekunden; Bild 5 2 Sekunden; Bild 6 1 Sekunde; Bild 7 1 Sekunde; Bild 8 2 Sekunden; Bild 9 2 Sekunden; Bild 10 2 Sekunden; Bild 11 2 Sekunden.</p>	1 2 3	Reckitt Benckiser N.V.	R	2006
----	----------	---	-------	------------------------	---	------

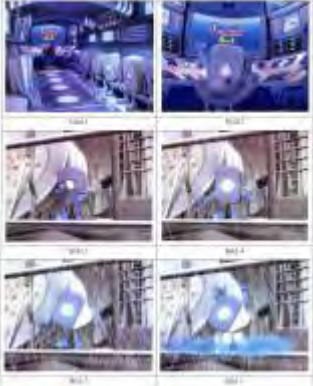
DE	30600892	 <p data-bbox="472 528 1254 1000">Bewegungsmarke, namentlich die Darstellung einer Folge von bewegten Bildern. Die Marke zeigt die graphische Darstellung in verschiedenen Perspektiven von bis zu sechs, sich bewegenden Geschirrspültabletten. Bei der Marke handelt es sich um den Bewegungsablauf von sieben Bildern (Darstellung 1 bis Darstellung 7 gemäß graphischer Wiedergabe), wobei diese in aufsteigender Reihenfolge ohne dazwischen liegende Pause gezeigt werden. Die einzelnen, in Bild 1 bis Bild 7 gezeigten Darstellungen, werden für folgende Zeitdauer gezeigt: Bild 1 1 Sekunde; Bild 2 1 Sekunde; Bild 3 1 Sekunde; Bild 4 1 Sekunde; Bild 5 1 Sekunde; Bild 6 1 Sekunde; Bild 7 1 Sekunde</p>	1 2 3	Reckitt Benckiser N.V.	R	2006
----	----------	--	-------	---------------------------	---	------

DE	30600893	 <p>Gegenstand der Markenmeldung ist eine Bewegungsmarke, namentlich die Darstellung einer Folge von bewegten Bildern. Die Marke zeigt die graphische Darstellung in verschiedenen Perspektiven von bis zu zehn, sich bewegenden Geschirrspültabletten. Bei der Marke handelt es sich um den Bewegungsablauf von sechs Bildern (Darstellung 1 bis Darstellung 6 gemäß graphischer Wiedergabe), wobei diese in aufsteigender Reihenfolge ohne dazwischen liegende Pause gezeigt werden. Die einzelnen, in Bild 1 bis Bild 6 gezeigten Darstellungen, werden für folgende Zeitdauer gezeigt: Bild 1 1 Sekunde; Bild 2 1 Sekunde; Bild 3 1 Sekunde; Bild 4 1 Sekunde; Bild 5 1 Sekunde; Bild 6 1 Sekunde 220AnmeldetagAT</p>	1 2 3	Reckitt Benckiser N.V.	R	2006
----	----------	--	-------	------------------------	---	------

DE	30655745	 <p data-bbox="477 730 1274 1351">fortlaufenden Sequenz von ineinander übergehenden Bildern, beginnend mit Bild 01 und endend mit Bild 05 in endlosen Wiederholungen. Die Gesamtlänge der Sequenz beträgt ca. 2 Sekunden mit je 30 Bildern pro Sekunde. Bild 01 zeigt zwei nach unten aufgefächerte Segmente die in der oberen rechten Ecke verbunden sind und sich quer von links unten nach rechts oben im Raum erstrecken, wobei das zweite Segment deutlich kürzer ist als das Erste. Auf dem linken, längeren Segment befinden sich sechs Streifen, auf dem rechten, kürzeren Segment vier Streifen. Das in den beigefügten Zeichnungen schematisch dargestellte geometrische Objekt läuft während des Bewegungsablaufs so schnell die Segmente auf und ab, dass es den Eindruck eines oszillierenden Sterns vermittelt, aber nicht als genaue Figur erfasst werden kann. Der Bewegungsablauf besteht darin, das sich das oszillierende geometrische Objekt dem linken</p>	9	Microsoft Corporation	R	2007
----	----------	--	---	-----------------------	---	------

		Segment entlang hinaufbewegt, am obersten Ende, wo die beiden Segmente verbunden sind, wendet und das kürzere Segment hinabläuft. Die Aufwärtsbewegung nimmt drei Fünftel des Zyklus in Anspruch, die Abwärtsbewegung zwei Fünftel. Während der Aufwärtsbewegung wechseln die Streifen des längeren Segments in der Reihenfolge von oben nach unten die Farben von dunkel nach hell. Während der Abwärtsbewegung wechseln die Streifen des kürzeren Segments in der Reihenfolge von links nach rechts die Farben von dunkel nach hell.				
DE	30707640	 <p>Bewegungsmarke, namentlich die Darstellung einer Folge von bewegten Bildern. Die Marke zeigt die graphische Darstellung in verschiedenen Perspektiven von einem, sich öffnenden Stifтетui. Dabei beginnt die erste Darstellung mit dem geschlossenen, transparenten Kunststoffteil und zeigt in den Bildern 2 - 5 den Öffnungsvorgang. Bild 6 zeigt das vollständig geöffnete Etui in seiner Funktion als Stiftehalter. Bei der Marke handelt es sich um den Bewegungsablauf von sechs Bildern (Darstellung 1 bis Darstellung 6 gemäß graphischer Wiedergabe), wobei diese in aufsteigender Reihenfolge ohne dazwischen liegende Pause gezeigt werden. Die einzelnen, in Bild 1 bis Bild 6 gezeigten Darstellungen, werden für</p>	16 17 20	J.S. STAEDTLER GmbH & Co. KG	R	2007

		folgende Zeitdauer gezeigt: Bild 1 zehn Sekunden; Bild 2 zwei Sekunden; Bild 3 zwei Sekunden; Bild 4 zwei Sekunden; Bild 5 zwei Sekunden; Bild 6 zehn Sekunden.				
DE	30733162	<p>Bild 1:</p>  <p>Bild 2:</p>  <p>Bild 3:</p>  <p>Bewegungsmarke, namentlich die Darstellung einer Folge von bewegten Bildern. Die Marke zeigt die sich bewegende grafische Darstellung einer Hand, welche eine Münze in ein mit Flüssigkeit gefüllten Behälter reinlegt. Bei der Marke handelt es sich um den Bewegungsablauf von drei Bildern (Darstellung 1 bis Darstellung 3 gemäß grafischer Wiedergabe), wobei diese in aufsteigender Reihenfolge für jeweils eine Sekunde ohne dazwischen liegende Pause gezeigt werden. Die einzelnen in Bild 1 bis Bild 3 gezeigten Darstellungen werden für folgende Zeitdauer gezeigt: Bild 1: 1 Sekunde, Bild 2: 1</p>	3	Reckit Benckiser N.V.	R	2008

		Sekunde, Bild 3: 1 Sekunde				
DE	302008 034943	<p>Gegenstand der Markenmeldung ist eine Bewegungsmarke, namentlich die Darstellung einer Folge von 6 bewegten Bildern. Die Marke zeigt die graphische Darstellung eines Balkendiagramms, einer Art Treppe, mit darüberlaufendem Männchen. In Bild (Phase) 1 steht das Männchen auf der ersten Säule und läuft nach rechts in Richtung zweiter Säule, wobei sich die Säulen dabei orange verfärben und dies jeweils 0,5 Sekunden dauert. Nach 2 Sekunden erreicht das Männchen die dritte Säule und färbt gleichzeitig die beiden ersten Säulen weiss, die drei rechten Säulen werden orange (Bild 2). Das Männchen setzt seinen Lauf nach 3 Sekunden fort, verharrt auf jeder Säule 0,5 Sekunden, um nach 4 Sekunden die letzte Säule, den fünften Balken am rechten Rand zu erreichen. Danach läuft das Männchen auf dem Boden weiter und verlässt die Bildfläche nach 1 Sekunde (Bild 3). Nach 1 Sekunde tritt das Männchen von rechts kommend wieder auf die Bildfläche und dreht sich gleichzeitig zum Betrachter, erscheint etwas größer und hat ein grün pochendes Kreuz anstelle des Herzens (Bild 4). Aus der Sicht des Betrachters hebt das Männchen den linken Arm in einer fließenden Bewegung, wobei synchron dazu die drei Säulen daneben 0,5 Sekunden anwachsen und dies grün gekennzeichnet ist (Bild 5). In Bild 6 bleibt das Männchen mit erhobenem Arm stehen. Das grüne Kreuz pocht weiter.</p> 	35 38 42	Helmerich, Jens,	R	2008
DE	302008	Gegenstand der Markenmeldung ist eine Bewegungs-	35 38 41	RMS Radio	R	2008

	0450223	<p>marke, namentlich die Darstellung einer Folge von bewegten Bildern mit einer Laufdauer von 4 Sekunden. Die Marke zeigt als sich bewegende graphische Darstellung, wie aus allen Teilen des Bildes zahlreiche gleich große Würfel in roter Farbe auf einen Punkt in der rechten Bildmitte zuschweben. Die Würfel bilden, nachdem sie aufeinander getroffen sind, einen größeren Würfel, der im Verhältnis der Kantenlängen den einzelnen kleineren Würfeln entspricht. Ebenso entspricht die Farbe des größeren Würfels derjenigen der kleineren Würfel. Der Würfel ist in perspektivischer Aufsicht von links vorne oben zu sehen. Zugleich mit der Bildung des größeren Würfels erscheint links vom Würfel in gleicher Höhe mit ihm der Schriftzug "RMS. Der Audiovermarkter", ebenso wie auf der dem Betrachter zugewandten Vorderseite des Würfels ein Quadrat mit weißen Linien, an dessen oberen Rand von unten anstoßend die Großbuchstaben "RMS", ebenfalls in weiß, eingeblendet werden. Sodann erscheint, wie von unsichtbarer Hand geschrieben, auf der Vorderseite des Würfels unterhalb der Buchstaben RMS ein etwa V-förmiger Haken, etwas über den unteren Rand des Quadrats aus weißen Linien nach unten ragend. Bei der Marke handelt es sich um den Bewegungsablauf von sechs Bildern (Sequenz 01 bis 06 gemäß graphischer Wiedergabe), wobei diese in aufsteigender Reihenfolge ohne dazwischen liegende Pause gezeigt werden. Die einzelnen Darstellungen werden zu folgenden Zeitpunkten im Ablauf der Bewegungsmarke gezeigt: Bild1: Anfangsbild, Bild 2: nach 1/3 Sekunde, Bild 3: nach 2/3 Sekunde, Bild 4: nach 1 Sekunde, Bild 5: nach 1 1/2 Sekunden, Bild 6: von 1 1/2 bis zum Ablauf der 4. Sekunde</p>	42 45	Marketing Service GmbH & Co. KG,		
--	---------	--	-------	----------------------------------	--	--

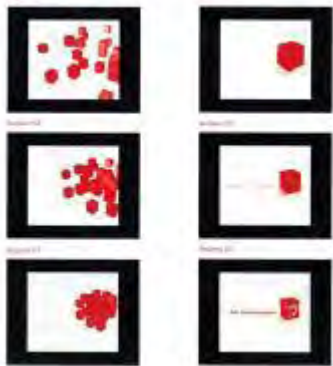
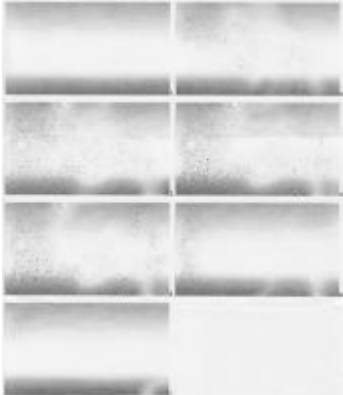
						
DE	302009 0342881	 <p>Es handelt sich um eine Bewegungsmarke, die darstellt, wie in immer gleicher und wiederkehrender Form als visuelles Element in Werbespots der Anmelderin das komplette für den Zuschauer erkennbare Bild „betaut“ wird. Das wiederkehrende Element besteht dabei darin, dass immer dann, wenn in einem Werbespot ein Schauspieler ein Getränk der Anmelderin zum Trinken ansetzt, der gesamte Bildschirm für den Zuschauer mit Tautropfen bedeckt wird, um den damit verbundenen Erfrischungseffekt zu versinnbildlichen. Dieses Element der Frische kommt in allen Werbematerialien zentral vor (z.B. „irgendwann erfrischt es jeden – Frisches Veltins“). Um den</p>	16 32 35	Brauerei C. & A. Veltins GmbH & Co.	R	2010

		Wiedererkennungswert zu gewährleisten, ist dieser Betauungseffekt in allen Werbespots, sowohl was die Verteilung der Tautropfen, als auch den zeitlichen Ablauf angeht, genau gleich ausgelegt. Die Markenmeldung bezieht sich ausdrücklich nicht auf die Betauung von im Bild erkennbaren Objekten, wie z.B. Bierflaschen oder -gläsern.				
DE	302012 0553923	 <p>Die Marke ist eine Bewegungsmarke, die aus einer silbernen Scheibe besteht, die entlang ihres äußeren Rands einen schwarzen Ring enthält. Ein weißes Licht, das übergeht in eine violette Spur, rotiert im Uhrzeigersinn entlang des Rings. Innerhalb des Rings befindet sich ein skizziertes Mikrofon mit einem schwarzen Sockel und einem violetten Körper. Der schwarze Kasten um den äußeren Kreis wird nicht als Merkmal der Marke beansprucht und soll nur den Hintergrund zeigen / The mark consists of a motion mark that consists of a silver disc containing a black ring around its outer edges. A white light that fades to a purple trail moves in a clockwise rotation around the ring. Inside the ring is the outline of a microphone, with a black base and a purple body that has a black shadowing effect to the lower right. The black box around the ring is not claimed as a feature of the mark, and is intended to show background only.</p>	9 28 35 38 43 45	Apple Inc	R	2013

DE	302012 0558925	 <p>Die Marke besteht aus dem Worтеlement „ad-artists“ und einem grafischen Element, einer grünen Kreisfläche. Nur das grafische Element ist beweglich. Die Bewegung ergibt sich daraus, dass die Kreisfläche, immer in gleicher Höhe bleibend, sukzessiv über die Zeichen des Worтеlements wandert: In der Ausgangsstellung befindet sie sich über dem „a“ von „artists“, wandert von dort bis zum letzten Buchstaben von „artists“, von diesem aus nach vorne bis zum „a“ von „ad“ und wieder zurück zur Ausgangsstellung. Den genauen Bewegungsablauf zeigt die grafische Wiedergabe der Bewegungsmarke in jedem Einzelschritt: Feld 01 zeigt die Ausgangsstellung, Feld 02 die zweite Position der Kreisfläche, Feld 03 die dritte Position der Kreisfläche usw.; in Feld 19 ist sie wieder in die Ausgangsstellung zurückgekehrt. Für den Weg von der Ausgangsstellung bis zu dieser zurück benötigt die Kreisfläche 2,80 Sekunden. Über jedem Zeichen verharret sie gleichlang. Bevor sie den Weg erneut aufnimmt, verbleibt sie 2,00 Sekunden in der Ausgangsstellung. Befindet sich die Kreisfläche über einem Zeichen, erscheint es in der Farbe Weiß. Nachdem sie es verlassen hat, wechselt die Farbe des Zeichens wieder zu Schwarz. Die Buchstaben und der Bindestrich sind, solange sich die grüne Kreisfläche nicht über ihnen befindet, in Schwarz gesetzt. Farb-Code der Buchstaben dabei ist: RGB: 26, 23, 27. Befindet sich die grüne Kreisfläche über einem Buchstaben bzw. dem</p>	9 28 35 38 41 42	mantel + schölzel	R	2013
----	-------------------	---	---------------------	-------------------	---	------

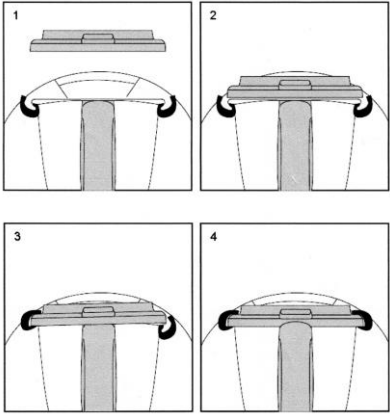
		Bindestrich, erscheinen sie in Weiß. Farb-Code der grünen Kreisfläche ist: RGB: 184, 208, 101				
DE	302014 0602431	 <p>Gegenstand der Anmeldung ist eine Bewegungsmarke, namentlich die Darstellung einer Folge von 4 bewegten Bildern. Die Marke bezieht sich auf den Vorgang des Schließens eines Behältnisses mit einem Deckel in der dargestellten einzigartigen und ungewöhnlichen Art und Weise. Die Dauer der gesamten Bewegung beträgt 2,8 Sekunden. Bild 1: Das Behältnis ist noch unbedeckt und die Greifarme sind geöffnet (1 Sekunde). Bild 2: Der Deckel liegt auf dem Behältnis auf und die Greifarme sind geöffnet (1 Sekunde). Bild 3: Der vom Betrachter aus gesehen linke Greifarm schließt sich um den Deckel und zieht die linke Seite des Deckels an das Behältnis heran. Der vom Betrachter aus gesehen rechte Greifarm bleibt in der Stellung unverändert (0,4 Sekunde). Bild 4: Auch der vom Betrachter aus gesehen rechte Greifarm schließt sich um den Deckel und zieht auch die rechte Seite des Deckels an das Behältnis heran (0,4 Sekunde).</p>	43	Vorwerk & Co Interholding GmbH	R	2015

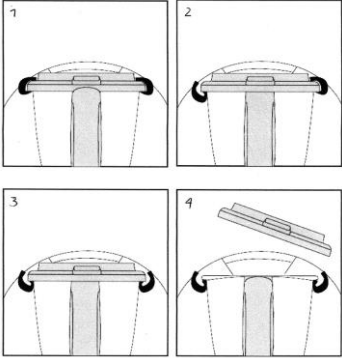
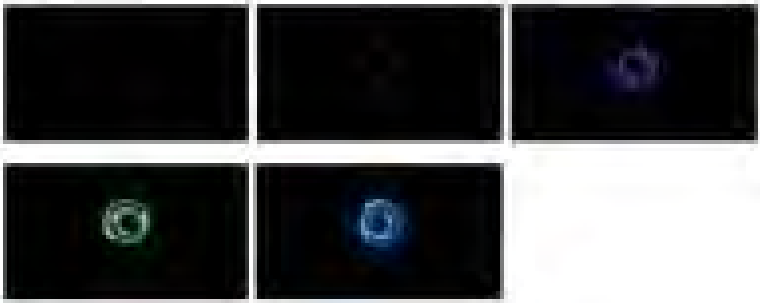
<p>DE</p>	<p>302014 0602458</p>	 <p>Gegenstand der Anmeldung ist eine Bewegungsmarke, namentlich die Darstellung einer Folge von 4 bewegten Bildern. Die Marke bezieht sich auf den Vorgang des Öffnens eines Behältnisses in der dargestellten einzigartigen und ungewöhnlichen Art und Weise. Die Dauer der gesamten Bewegung beträgt 2,8 Sekunden. Bild 1: Das Behältnis ist mit dem Deckel bedeckt, der durch zwei Greifarme fixiert wird (1 Sekunde). Bild 2: Der vom Betrachter aus gesehen linke Greifarm löst sich von dem Deckel. Der vom Betrachter aus gesehen rechte Greifarm bleibt unverändert (0,4 Sekunde). Bild 3: Auch der vom Betrachter aus gesehen rechte Greifarm löst sich von dem Deckel (0,4 Sekunde). Bild 4: Der Deckel liegt nicht mehr auf dem Behältnis auf und beide Greifarme sind geöffnet (1 Sekunde).</p>	<p>43</p>	<p>Vorwerk & Co Interholding GmbH</p>	<p>R</p>	<p>2015</p>
<p>DE</p>	<p>302015 0497886</p>		<p>7 9 10 11 14 42</p>	<p>Samsung Electronics Co Ltd</p>	<p>E</p>	<p>2016</p>

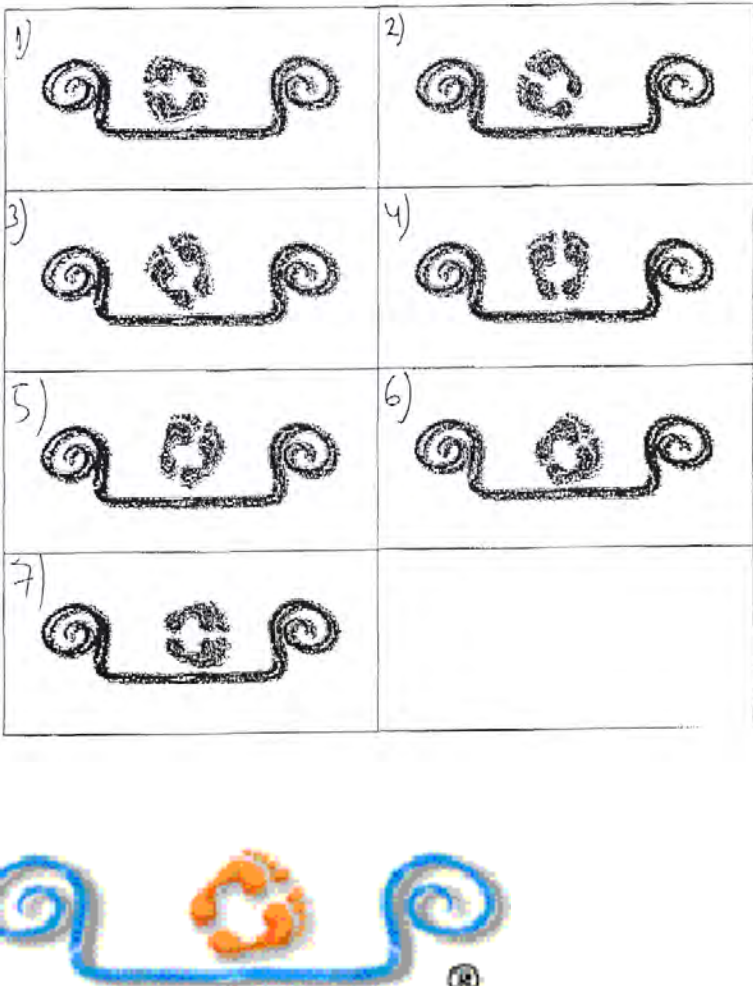
DK	2002 01159		6 10 20	H.C. Equipment ApS	R	2002
----	------------	---	---------	--------------------	---	------

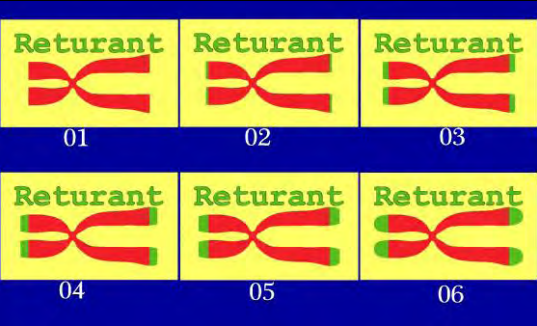
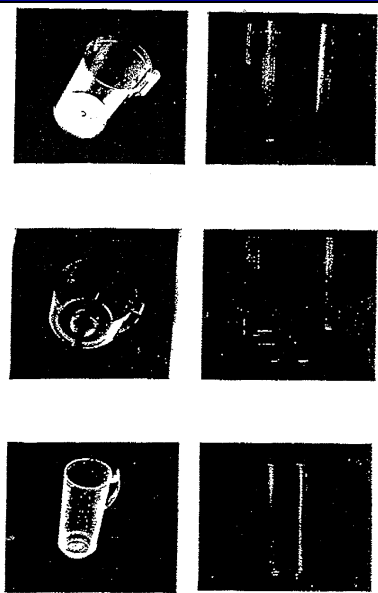

DK	VA 2011 03563		41 43 44	Ole larsen	E W	2012
EM	522144	 <p data-bbox="477 1094 1240 1235">Besteht aus einem durchsichtigen Behälter oder Sammelbehälter als Teil der äußeren Oberfläche eines Staubsaugers. The mark consists of a transparent bin or collection chamber forming part of the external surface of a vacuum cleaner.</p>	7	Notetry Ltd	E A	2003

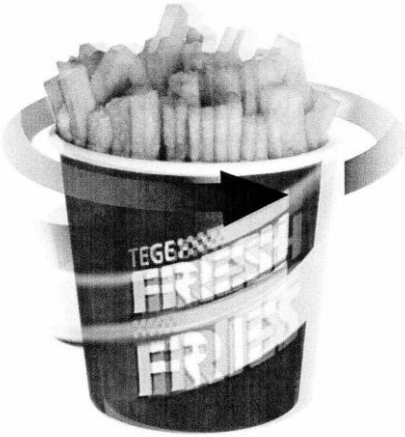
EM	696872	 <p data-bbox="472 582 1249 984">Besteht aus einem sich bewegenden zweidimensionalen Bild. Die vier graphischen Darstellungen der Marke zeigen vier Beispiele für verschiedene Positionen der sich bewegenden Marke. Die Marke besteht aus einem Mund, dessen Lippen sich synchron zu den gesprochenen Wörtern bewegen. Sie vermittelt den visuellen Eindruck eines "sprechenden" Mundes. The mark is a moving 2-dimensional image. The four graphic representations of the mark show four examples of different positions of the mark in movement. The mark is a mouth, the lip positions of which change in synchronisation to spoken words. The mark captures the visual effect of the mouth as it 'speaks'.</p>	3 5 21	Beecham Group plc	E A W	2000
----	--------	--	--------	-------------------	-------	------

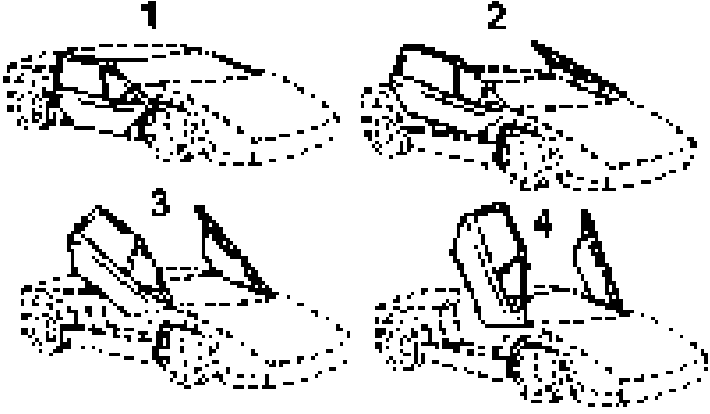

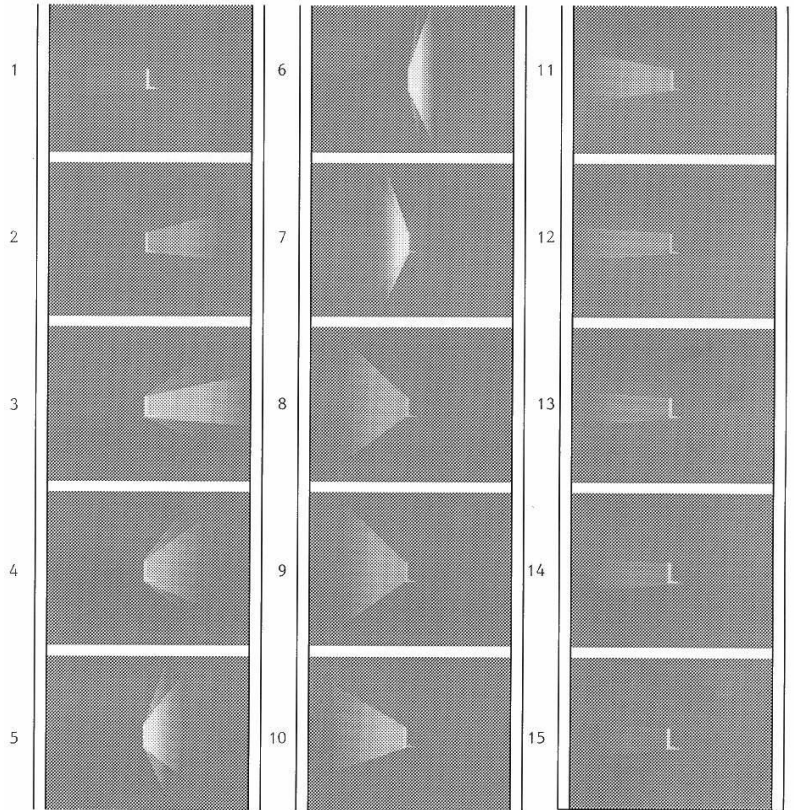
EM	1222256	 <p data-bbox="472 624 1258 944">Die Handelsmarke besteht aus einer rotierenden Schale mit Pommes frites, die sich mit einer Geschwindigkeit zwischen 500 und 700 Umdrehungen pro Minute bewegt, wie lediglich zur Veranschaulichung in der beiliegenden graphischen Darstellung gezeigt; die Rotation kann im Uhrzeigersinn oder gegen den Uhrzeigersinn erfolgen. The trade mark consists of a spinning cup of french fried potatoes rotating at a speed of between 500 and 700 rpm as shown for illustrative purposes only in the attached graphic representation; the direction of spin may be clockwise or anti-clockwise.</p>	29	TE GE Patent AG	E W	2003
----	---------	--	----	-----------------	-----	------

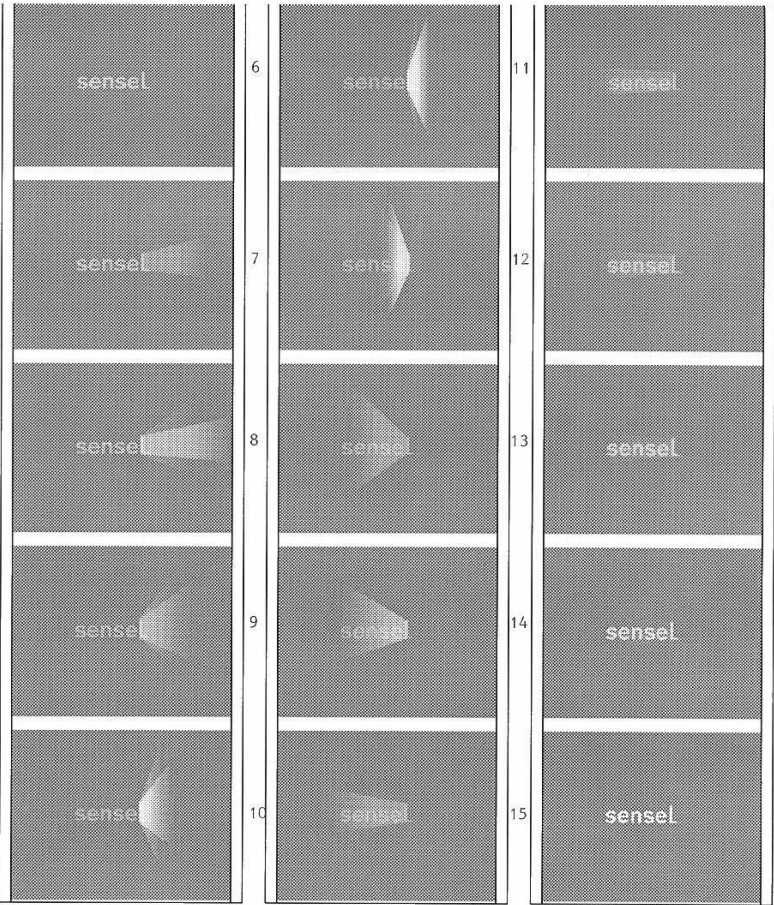
EM	1400092	 <p data-bbox="472 659 1261 986">Die Marke bezieht sich auf eine eigenartige und charakteristische Ausgestaltung der Türen eines Fahrzeuges. Die Türen werden zum Öffnen, "nach oben verschwenkt", und zwar um eine Schwenkachse, die im wesentlichen horizontal und quer zur Fahrtrichtung des Fahrzeuges verläuft. The trademark refers to a typical and characteristic arrangement of the doors of a vehicle. For opening the doors are "turned upwardly", namely around a swivelling axis which is essentially arranged horizontal and transverse to the driving direction.</p>	12 28	Automobili Lamborghini	E A W	2004
----	---------	---	-------	------------------------	-------	------

EM	1772615	 <p data-bbox="472 1007 1263 1254">Bewegliche Marke. The mark is a moving trademark consisting of the letter L with a light beam moving from right to left. The numbers 1-15 indicate the order of the frames and are not part of the mark. The mark is a moving trademark consisting of the letter L with a light beam moving from right to left. The numbers 1-15 indicate the order of the frames and are not part of the mark.</p>	9 36 38 42	Sensel AB	E R	2003
----	---------	--	---------------	-----------	-----	------

EM	1779412	 <p data-bbox="472 1106 1256 1249">Bewegliche Marke. The mark is a moving trademark consisting of the word <code>sensenL</code> with a lightbeam moving from the right to left. The numbers 1-15 indicate the order of the frames and are not part of the mark.</p>	9 36 38 42	Sensel AB	E R	2003
EM	1864610		35 41 42	Berggren OY	R	2002

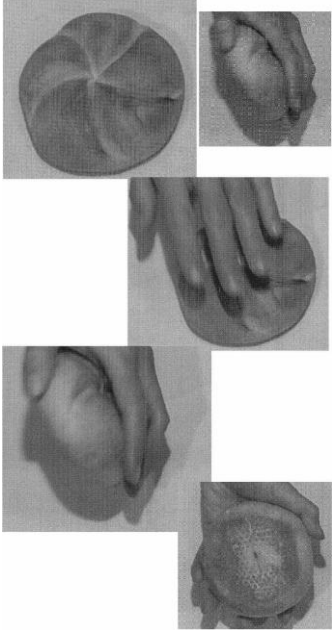
		<p>Das Zeichen besteht aus sechs Stillbildern, die ein bewegtes Bild darstellen (die laufenden Nummern gehören nicht zum Zeichen). Der Anfangspunkt ist das Bild Nummer 1, auf dem ein stilisierter grüner Vogel zu sehen ist, der seine Flügel ausbreitet. Auf den nächsten Bildern öffnet/öffnen sich der Flügel/die Flügel des Vogels progressiv bis zu Maximalstellung, die auf dem letzten Bild Nummer 6 zu sehen ist. Der oben beschriebene Prozess wiederholt sich beginnend mit dem Bild Nummer 1. The mark comprises six still pictures representing a moving image (the numerical indications do not belong to the mark). Picture number 1 is the starting point with a stylized green coloured bird starting to open its wings. In the subsequent pictures the bird's wing/s is/are opening progressively to the highest position which is shown in the final picture number 6. The process described above then repeats itself beginning from picture 1.</p>				
EM	1910553	 <p>Besteht aus der Darstellung eines bewegten Bildes in Form einer animierten Bildsequenz, die einen quadratischen Punkt mit abgerundeten Ecken und die Buchstaben Y, E, L und L zeigt. Nachdem anfänglich ein leerer quadratischer Punkt mit abgerundeten Ecken für wenige Sekunden angezeigt wird, erscheinen dann die Buchstaben Y, E, L und L in schneller Folge in diesem quadratischen Punkt, so dass sich das Wort YELL ergibt. Die Buchstaben werden durch die kurze Anzeige des leeren Punktes voneinander getrennt. Die Darstellung besteht aus acht Einzelbildern, aus denen sich die Sequenz zusammensetzt. The moving image design mark consists of an animated visual sequence depicting a square dot with rounded corners and the letters Y, E, L, and L. After the initial display of the empty square dot with rounded corners for a few seconds, the letters Y, E, L and L</p>	9, 16, 35, 36, 37, 38, 39, 41, 42	Yell Ltd	E O	2006

						
EM	2395473	 <p data-bbox="474 1295 1227 1364">Bild 01: Ein grüner und ein brauner Fleckenzwerg haben sich auf einem gelben Textil festgesetzt und schauen wild drein (Darste-</p>	3 16 21	Henkel KGaA	E R	2005

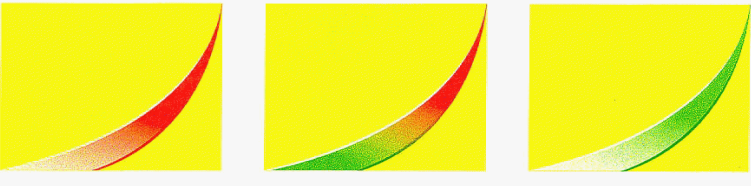
		<p>llungsdauer: 0,4 sec.). Bild 02: Waschmittel-Gel kommt auf das Textil und auf den braunen Fleckenzwerg, der grüne Fleckenzweg ist noch unbeteiligt (Darstellungsdauer: 0,4 sec.). Bild 03: Der braune Fleckenzwerg schluckt das Waschmittel-Gel und schließt die Augen, der grüne Fleckenzwerg verschließt ebenfalls die Augen (Darstellungsdauer: 0,4 sec.). Bild 04: Der braune Fleckenzwerg verdaut das Waschmittel-Gel mit geschlossenen Augen, der grüne Fleckenzwerg guckt entgeistert (Darstellungsdauer: 0,4 sec.). Bild 05: Der braune Fleckenzwerg beginnt langsam zu verschwinden, löst sich auf und der grüne Fleckenzwerg schaut nervös (Darstellungsdauer: 0,4 sec.). Bild 06: Der braune Fleckenzwerg ist vollständig verschwunden, das Waschmittel-Gel spritzt in sämtliche Richtungen und der grüne Fleckenzwerg wird ebenfalls getroffen (Darstellungsdauer: 0,4 sec.). Die Gesamtdauer der Animation beträgt 2,4 sec.</p>				
EM	2421667	 <p>Die Marke stellt eine Bewegung dar, und zwar eine Reihe sich bewegender Bilder. Eine Reihe von drei Bildern (von links nach rechts) in Form einer Wellen-/Drehbewegung wird dargestellt, bei der die Farbe in der Wellen-/Drehbewegung sich von links unten nach rechts oben von Rot nach Grün mit einer Frequenz von einer Sekunde verändert. Grün (Pantone 347), gelb (Pantone 102), rot (Pantone 485).</p> <p>The mark designates a movement respectively a series of moving pictures. A set of three pictures (from the left to the right) regarding a wave/sweep is shown, whereas the colour within the wave/sweep is changing from red into green in direction from the bottom (left corner) to the top (right corner) with a frequency of 1 second. Green (pantone 347), yellow (pantone 102), red (pantone 485).</p>	5	Bayer Consumer Care AG	E (R)	2003

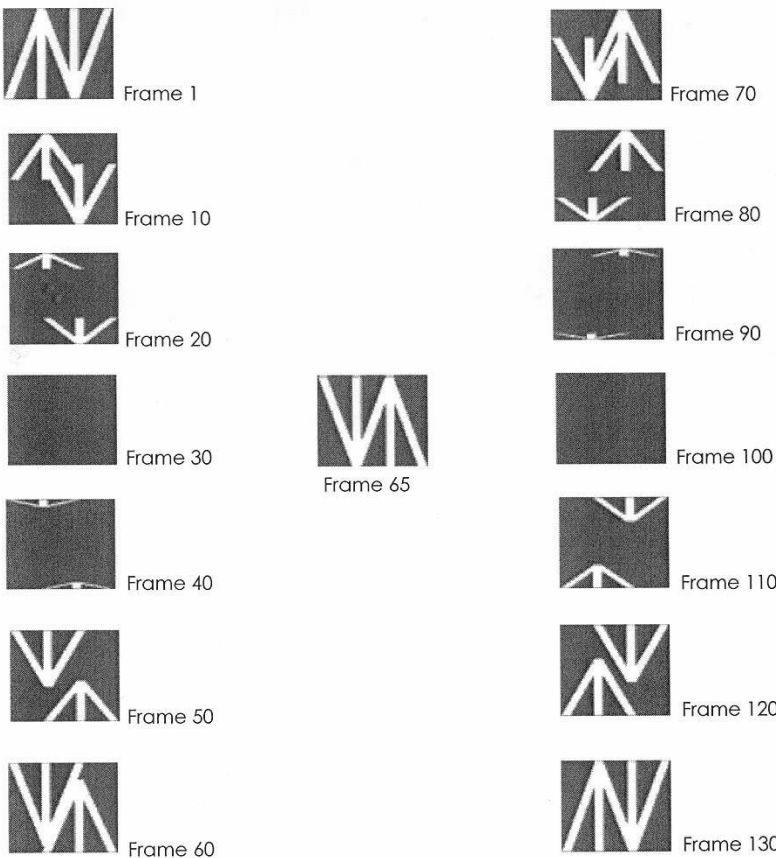
EM	2441202	 <p>Frame 1</p> <p>Frame 10</p> <p>Frame 20</p> <p>Frame 30</p> <p>Frame 40</p> <p>Frame 50</p> <p>Frame 60</p> <p>Frame 65</p> <p>Frame 70</p> <p>Frame 80</p> <p>Frame 90</p> <p>Frame 100</p> <p>Frame 110</p> <p>Frame 120</p> <p>Frame 130</p> <p>First definition: a constantly-running sequence of images blending one into the next as shown by the representative frames in the sequence shown in the accompanying drawing, starting with frame 1 and finishing at frame 130, repeating indefinitely; second definition: the mark consists of a series of images displayed sufficiently rapidly to give the allusion of a continuously cycling sequence of a pair of moving and changing arrows; the shafts of the arrows move along parallel paths over a defined field, the arrows moving in opposed directions; the path of movement of the</p>	9 35 41 42	Bi-d .tv Ltd	R	2004
----	---------	--	---------------	--------------	---	------

		<p>shaft of one arrow is approximately one-third of the distance across the field from one side edge and that of the other approximately one-third of the distance across the field from the opposed side edge; for each arrow, the free tip of one flight moves along the side edge of the field and the free tip of the other approximately one-third of the distance across the field from the opposed side edge; for each arrow, the free tip of one flight moves along the side edge of the field and the free tip of the other flight moves along the path of the shaft of the other arrow; in the first quarter cycle of the sequence, the arrow grows from a transverse edge of the field by the shaft extending along its path while the tips of the flights remain stationary, until the tip of the shaft reaches the opposed transverse edge; in the next quarter cycle, the tip of the shaft remains stationary while the free tips of the flights and the rail of the arrow shaft move along their respective paths until the arrow shrinks once more to nothing; in the third and fourth quarter cycles, the motion of the arrows is reversed; the mark is exemplified by the sequence of representative frames attached the first quarter cycle starting at frame 30 and finishing at frame 65, the second from frame 65 to frame 100, the third from frame 100 to frame 130 and the fourth from frame 1 to frame 30.</p>				
--	--	--	--	--	--	--

EM	2762813	 <p data-bbox="472 1345 1261 1377">Bewegungsmarke bestehend aus 6 Einzelbildern. Die Darstellungs-</p>	3 21	Hans Schwarzkopf GmbH & Co KG	E (R)	2003
----	---------	---	------	-------------------------------	--------	------

		<p>dauer beträgt 14,5 Sekunden; nachfolgend wird die filmische Darstellung konkretisiert; es wird die Bewegung einer Hand gezeigt, die über das Haar einer Frau streicht; Bild 1: Darstellungsdauer: 1 Sekunde; eine Frau im Seitenprofil (Kopf nach links gedreht) ist zu sehen; eine Hand liegt auf Ihrem Haar, nicht weit vom Haaransatz entfernt; Bild 2: Darstellungsdauer: 1,5 Sekunden: die Hand streicht über das Haar der Frau; von der Frau ist nur ihr Haar und das linke Auge zu sehen; das Haar schimmert am Haaransatz; Bild 3: Darstellungsdauer: 2 Sekunden; Die Hand streicht über das Haar der Frau und befindet sich weiter unterhalb am Haar; der Schimmer auf ihrem Haar bewegt sich wie die Hand die Haare entlang nach unten; Seitenprofil der Frau (Kopf nach links gedreht, lediglich linkes Auge erkennbar); Bild 4: Darstellungsdauer: 2,5 Sekunden: die Hand streicht weiter über das Haar der Frau; Am Haaransatz erscheinen weiße Punkte; darunter erscheint ein Schimmer auf dem Haar; Seitenprofil der Frau, Kopf nach links gedreht, Gesicht bis zum Mund erkennbar; Bild 5: Darstellungsdauer: 3,5 Sekunden: Die weißen Punkte und der Schimmer auf dem Haar bewegen sich weiter abwärts am Haar entlang; die Hand ist nicht mehr zu sehen; Bild 6: Darstellungsdauer: 4 Sekunden: Seitenprofil der Frau ohne Hand auf ihrem Haar; die weißen Punkte und der Schimmer bewegen sich weiter abwärts und befinden sich am Haarende. / Moving mark consisting of 6 individual images. The representation time is 14.5 seconds; the filmic representation is set out as follows; the movement of a hand is shown, stroking the hair of a woman; image 1: representation time: 1 second; the side profile of a woman is shown (head turned to the left); a hand lies on her hair, not far from the hairline; image 2: representation time: 1.5 seconds: the hand strokes the woman's hair; only the hair and the left eye of the woman are visible; her hair has a sheen at the hairline; image 3: representation time: 2 seconds; the hand strokes the woman's hair, coming to rest further down the hair; the sheen on her hair moves as the hand moves</p>				
--	--	---	--	--	--	--

		downwards;side profile of the woman (head turned to the left, only the left eye showing);image 4: representation time: 2.5 seconds: the hand continues to stroke the woman's hair;white dots appear at the hairline;a sheen appears on the hair underneath;side profile of the woman, head turned to the left, face showing down to the mouth;image 5: representation time: 3.5 seconds: the white dots and the sheen on the hair move further downwards along the hair;the hand is no longer visible;image 6: representation time: 4 seconds: side profile of the woman without the hand on her hair;the white dots and the sheen move further downwards and come to rest at the end of the hair				
EM	2818334	 <p>Zwei Hände formen ein "T", indem aus Sicht des Betrachters die rechte Hand flach ausgestreckt mit den Fingerkuppen nach oben gerichtet (so dass nur die schmale Handkante zu sehen ist) sich von links</p>	9 16 35 38 42	Deutsche Telekom	E	2005

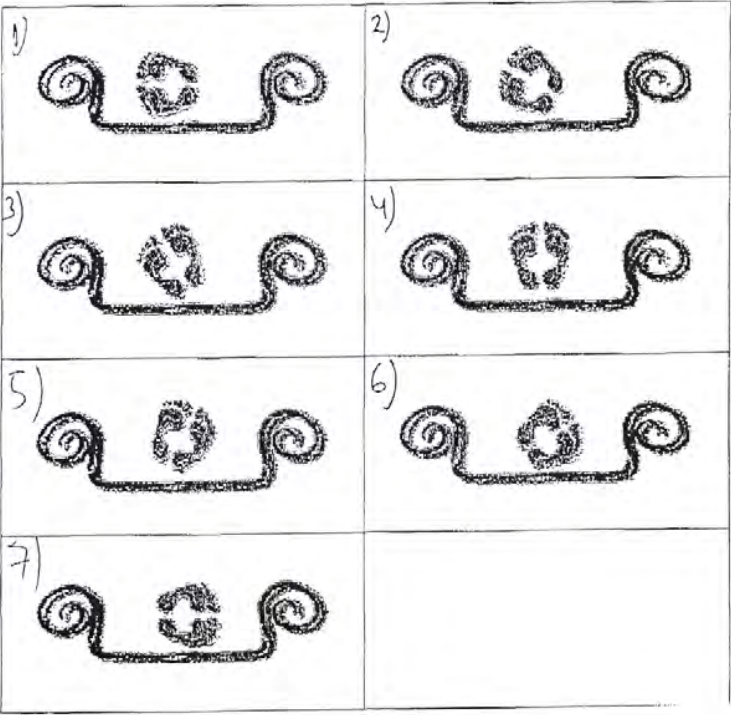
		<p>unten zur Bildmitte hin bewegt, während sich die linke Hand, ebenfalls flach ausgestreckt mit den Fingerkuppen nach oben gerichtet und in der Seitenaufsicht, vom rechten oberen Bildbereich in die Mitte bewegt; beide Hände treffen sich sodann in der Bildmitte, wobei die nach oben gerichteten Fingerkuppen der rechten Hand auf die Fläche der linken Hand etwa in deren Mitte auftreffen; der Betrachter sieht also in der Seitenaufsicht, wie die von oben kommende linke Hand auf den Fingerkuppen der von unten kommenden rechten Hand zum Ruhen kommt; für den Betrachter ist an dieser Stelle der Buchstabe "T" sozusagen als Ergebnis der Bewegung erkennbar</p>				
EM	2857704	 <p>Abbildung 1: Die Füße weisen nach links; Abbildung 2: Die Füße haben sich 60 Grad nach rechts bewegt, 0,25 Sekunden; Abbildung</p>	6 10 20	H.C. Equipment ApS	R	2004

		<p>3: Die Füße haben sich um weitere 20 Grad nach rechts bewegt, 0,2 Sekunden; Abbildung 4: Die Füße haben sich um weitere 10 Grad in vertikaler Richtung bewegt, 0,15 Sekunden; Abbildung 5: Die Füße haben sich um weitere 10 Grad nach rechts bewegt, 0,15 Sekunden; Abbildung 6: Die Füße haben sich um weitere 20 Grad nach rechts bewegt, 0,2 Sekunden; Abbildung 7: Die Füße haben sich um weitere 60 Grad nach rechts bewegt und befinden sich nun in waagerechter Position im Verhältnis zur gegenüberliegenden Abbildung 1, 0,25 Sekunden. Die Füße werden in entgegengesetzter Richtung zur obigen Beschreibung in die in Abbildung 1 beschriebene Position zurückbewegt. / Figure 1: the feet point to the left; figure 2: the feet have moved 60 degrees to the right, 0,25 seconds; figure 3: the feet have moved 20 degrees more to the right, 0,2 seconds; the feet have moved 10 degrees more vertical, 0,15 seconds; figure 5: the feet have moved 10 degrees to the right, 0,15 seconds; figure 6: the feet have moved 20 degrees to the right, 0,2 seconds; figure 7: the feet have moved 60 degrees more to the right and are now horizontal to the opposite side of figure 1, 0,25 seconds. The feet will twist back again into position (figure 1) the opposite way of the abovementioned description.</p>				
--	--	---	--	--	--	--

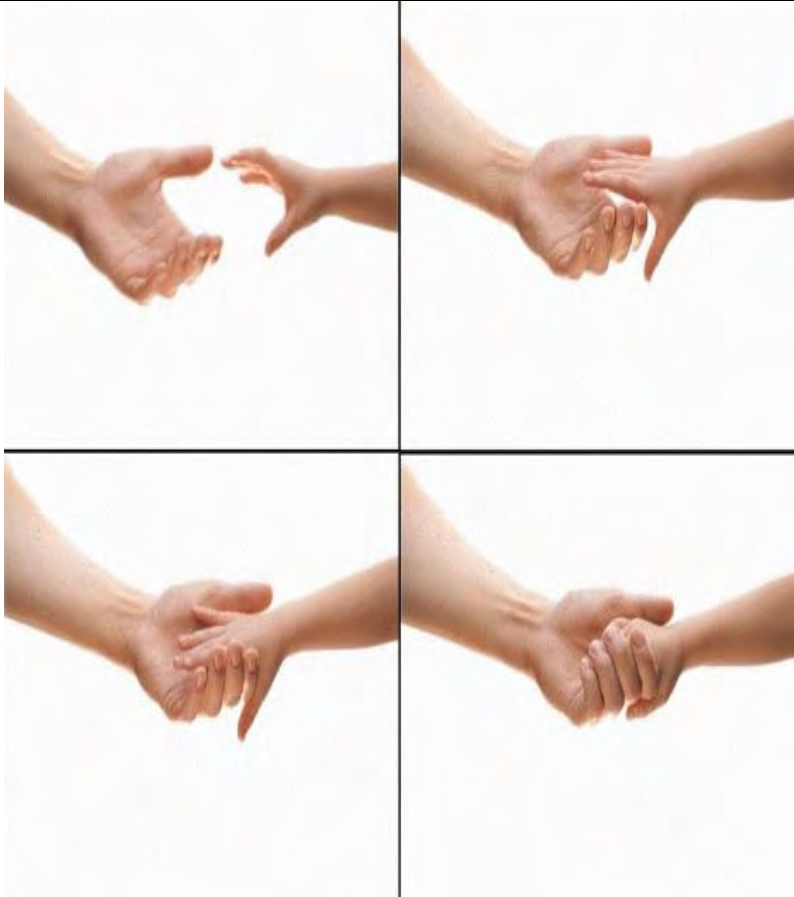
EM	3429909	 The image consists of four sequential frames of an animation, arranged in a 2x2 grid. Each frame shows two hands, one from the left and one from the right, moving towards each other. In the top-left frame, the hands are just starting to meet. In the top-right frame, the fingers are beginning to interlock. In the bottom-left frame, the hands are more fully engaged. In the bottom-right frame, the hands are fully clasped together in a firm grip. The background is a plain, light color.	9 28 38	NOKIA Corp.	R	2005
		<p>Die Marke ist eine Animation, die aus vier Bildern besteht, auf denen sich Hände nacheinander von links nach rechts und von oben nach unten begegnen / The mark comprises an animation which consists of four images depicting hands coming together, shown in succession from left to right and from top to bottom</p>				

EM	4087193	 <p data-bbox="1081 810 1126 842">Die</p> <p data-bbox="472 847 1256 1359">Bewegungsmarke gibt den Vorgang des gleichmäßigen Sinkens eines aus Zucker hergestellten "Schiffchens" innerhalb einer Zeitspanne von ca. 12 Sek. (Mittelwert aus Schwimmvorgang (5-15 Sek.) und Sinkvorgang (1-3 Sek.) zzgl. Auflösungszeit zwischen 30 und 180 Sek.) in Wasser und/oder einer ganz überwiegend aus Wasser bestehenden Flüssigkeit, nämlich Kaffee oder Tee, wieder, dargestellt durch sechs zeitlich aufeinander folgende zweidimensionale Abbildungen. The movement mark indicates the procedure for the simultaneous sinking of a "small ship" made of sugar, within a time frame of approximately. 12 seconds. (mean value from the floating process (5-15 seconds) and sinking process (1-3 seconds) plus dissolving time of between 30 and 180 seconds) in water and/or a liquid consisting mainly of water, namely coffee or tea, represented by six chronological, two-dimensional illustrations...</p>	30 35 43	Fraggies Vertriebsgesellschaft	R	2006
----	---------	---	----------	-----------------------------------	---	------

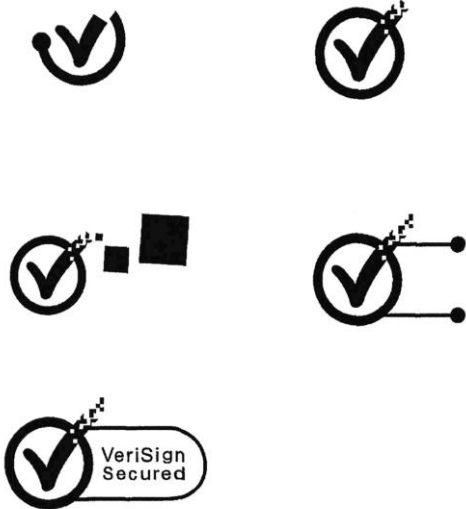
EM	4366001	 <p>The mark consists of a series of movements depicted as follows: Step 1 shows the beginning of the check mark element being drawn, as well as the beginning of the circle element being drawn; and step 2 shows the check mark element continuing to be drawn and the completion of the circle element; and step 3 shows the complete circle design, the check mark element continuing to be drawn through the addition of square elements moving into place to form the pixilized end of the check mark; and step 4 shows the complete circle element, the complete check mark element, and the start of the capsule element being drawn as it extends from the right-hand side of the circle element at the top and bottom; and finally, step 5 shows the complete mark consisting of the circle element, check mark element (including the pixilized end of the check mark), capsule element extending off of the right-hand side of the circle element framing the wording "VERISIGN SECURED"..Besteht aus einer Reihe von Bewegungsabläufen, die wie folgt dargestellt sind: Schritt 1 zeigt die angefangene Zeichnung des Häkchens sowie die angefangene Zeichnung des Kreiselements; und Schritt 2 zeigt den</p>	9 35 36 41 42	Verisign Inc	R	2006
----	---------	---	------------------	--------------	---	------

		weiteren Verlauf der Zeichnung des Hähchens und die Vollendung des Kreiselements; und Schritt 3 zeigt das vollständige Kreiszeichen, den weiteren Verlauf der Zeichnung des Hähchens durch hinzukommende quadratische Elemente, die sich zurechtrücken und so das verpixelte Hähchenende bilden; und Schritt 4 zeigt das vollständige Kreiselement, das vollständige Hähchenelement und die angefangene Zeichnung des Kapselements, das sich oben und unten von der rechten Seite des Kreiselements erstreckt; und Schritt 5 zeigt schließlich die vollständige Marke, bestehend aus Kreiselement, Hähchenelement (einschließlich verpixeltes Hähchenende), Kapselement als Fortsatz auf der rechten Seite des Kreiselements und als Umrahmung der Wortgruppe "VERISIGN SECURED"..				
EM	4623039	The mark consists of a moving image whereby a solid sphere comprising of two interlocking helices with a shared axis of rotation, each with a pitch equal to the diameter of the sphere, transforms smoothly in a single sequence of movement so that the interlocking helices beginning as a sphere separate moving slowly through each other's axis up and down until separated and then reversing the motion until the helices end again as a sphere Besteht aus einem beweglichen Bild, bei dem eine feste Kugel, die aus zwei ineinander greifenden Wendeln mit einer gemeinsamen Rotationsachse besteht, wobei der Mittenabstand jeweils dem Durchmesser der Kugel entspricht, allmählich zu einer einzigen Bewegungssequenz wird, sodass sich die als Kugel beginnenden ineinander greifenden Wendeln trennen und sich langsam auf und ab durch die jeweils andere Wendel bewegen, bis sie sich von einander getrennt haben, sich dann in umgekehrter Bewegung	14 28 35	Jonathan Hawkes	R	2006

		 <p>wieder vereinen und als Kugel enden</p>				
--	--	--	--	--	--	--

EM	4786653		<p>Besteht aus einer rotierenden Walze, deren Durchmesser größer ist als die Höhe, auf der zentral eine Walze angeordnet ist, deren Durchmesser kleiner ist als die Höhe. Auf der seitlichen Fläche der unteren Walze sind gegenüberliegend zwei Aufschriften SAWEX angeordnet, die mit großen Druckbuchstaben geschrieben sind, darunter befinden sich Linien von unterschiedlicher Dicke, deren Enden spitz verlaufen. Auf der oberen Walze liegt eine ineinander verflochtene räumliche Figur auf /</p> <p>The trademark consists of a turning cylinder with a large diameter and low height with a cylinder with a smaller diameter and a larger height placed on it centrally. On the lateral surface of the bottom cylinder, on the opposite sides, are two words, "SAWEX", in upper-case block letters, below which are lines of variable thickness ending with pointed tips. On the top of the cylinder is an interlacing spatial figure</p>	9 35 37 41 42	Slawomir Jakowski	E R	2008
----	---------	---	--	------------------	-------------------	-----	------



EM	4799318	 <p> Straight line Initial formation of the smile Curvature becomes more apparent Formation of the smile Smile is fully formed </p> <p> The Trade Mark consists of a sequence of animated images depicting the words "ITS GOOD TO BE HOME" starting in a straight line and moving upwards at either end to form a smile Die Marke besteht aus einer Bildfolge mit der Wiedergabe der Worte "its good to be home" in form einer Linie, die sich konkav zu einem Lächeln hier bewegt.. </p>	3 4 5 21	Reckit Benckiser	E R	2007
EM	5034624	 <p> 1 2 3 4 5 6 7 </p> <p>The trade mark consists a moving</p>	3 4 5 21	Reckit Benckiser	E	2008

		image of an animated monkey housewife character illustrated in the first frame of the sequence who is depicted in frames 2-7 in a family home, sniffing the air before tidying up as represented in the sequence of still pictures attached				
EM	5083514	 <p>The trade mark consists a moving image of an animated raccoon housewife character illustrated in the first frame of the sequence who is depicted in frames 2-7 in a family home, sniffing the air before tidying up and dusting as represented in the sequence of still pictures attached</p>	3 4 5 11	Reckit Benckiser	E	2008

EM	5083671	 <p data-bbox="474 726 1272 1350">Besteht aus einem sich bewegenden Bild des leuchtenden Vollmondsymbols. In Bild 1 ist das Mondsymboll unbeweglich, darunter befindet sich der Satz "It's good to be home" in einer geraden Linie. Nach einer halben Sekunde beginnt das Symbol, wie in Bild 2 dargestellt, sich wie beim Einatmen auszudehnen und der Satz "It's good to be home" beginnt, sich leicht nach oben zu biegen. In der nächsten halben Sekunde dehnt sich das Symbol weiter aus, wird größer und die Biegung des Satzes "It's good to be home" wird deutlicher sichtbar. Dies dauert noch eine weitere halbe Sekunde an. In Bild 4 beginnt das Mondsymboll, wieder auf seine normale Größe zu schrumpfen, der Satz "It's good to be home" wird zu einem Lächeln um den Mond herum. Innerhalb der nächsten halben Sekunde fällt das Mondsymboll wieder vollständig in sich zusammen und erreicht seine ursprüngliche Größe und Form in Bild 5. Der Satz "It's good to be home" bildet nun ein Lächeln um den Mond. Der gesamte Ablauf vollzieht sich innerhalb von zwei Sekunden The trade mark</p>	3 5 11	Reckit Benckiser	E R	2007
----	---------	---	--------	------------------	-----	------

		consists of a moving image of the glowing full moon icon. In frame 1 the moon icon is stationary with the "It's good to be home" wording positioned in a straight line under the moon. Within 0.5 of a second, and shown in frame 2, the icon begins to expand as if inhaling a large breath and the "It's good to be home" wording begins to curve slightly upwards. In the next 0.5 of a second, the icon continues expanding, thus getting larger and the curvature of the "It's good to be home" wording becomes more apparent. This continues for another 0.5 of a second. The moon icon begins to deflate in frame 4 with the "It's good to be home" wording beginning to form a smile around the moon. The moon icon fully deflates within the next 0.5 of a second to return to its original size and shape in frame 5. The "It's good to be home" wording now forms a full smile around the moon. The whole movement is completed in 2 seconds				
EM	5091574	The trade mark consists a moving image of an animated elephant housewife character illustrated in the first frame of the sequence who is depicted in frames 2-7 in a family home, tidying up and talking, before sniffing the air as represented in the sequence of	3 4 5 11	Reckit Benckiser	E	2008

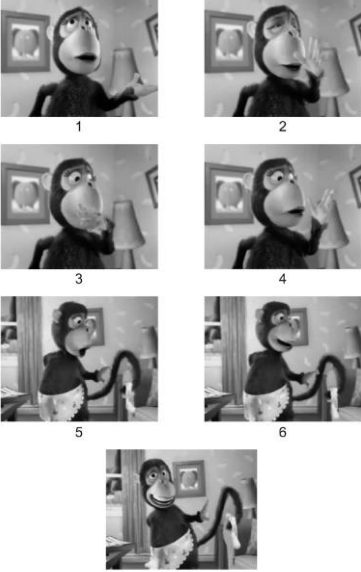

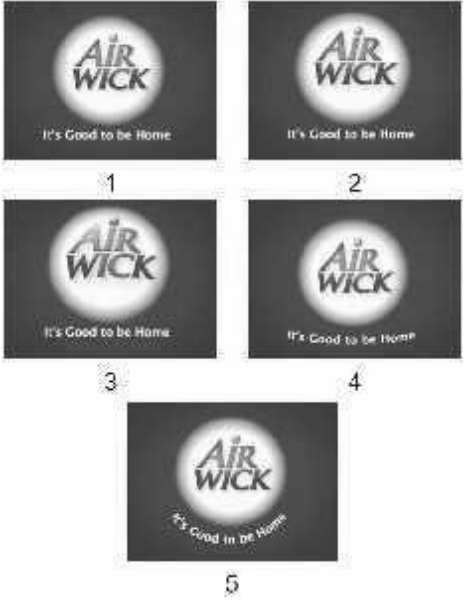
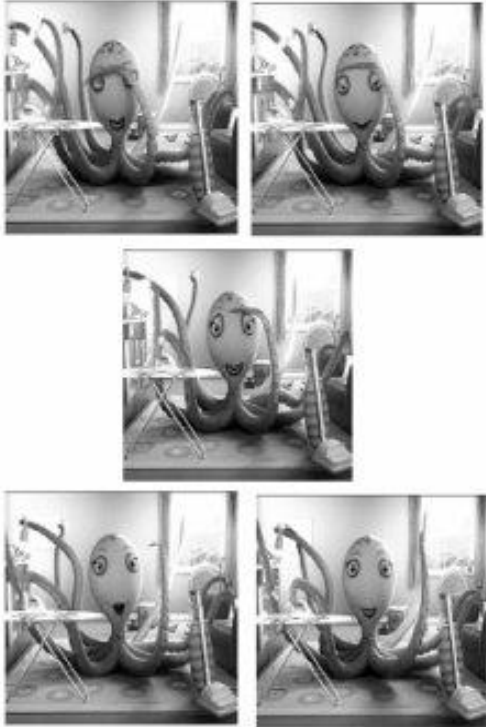
		 <p>still pictures attached</p>				
EM	5213723	 <p>La marque consiste</p>	9 16 25 28 41	La Francaise des Jeux S.A.	E W	2007

		<p>en une marque en mouvement en trois dimensions. Le mouvement de la marque consiste dans le déplacement du coeur qui vient se superposer sur la feuille du trèfle située la plus à droite et illustre l'impact visuel du coeur lorsqu'il bat. En effet, les quatre représentations graphiques de la marque montrent les quatre positions différentes de la marque en mouvement et illustrent le cheminement du coeur qui vient de la droite et se déplace jusqu'à atteindre sa place pour se superposer sur l'une des feuilles du trèfle. Les deux premières représentations graphiques capturent également l'effet visuel du battement du coeur qui a lieu lorsqu'il se déplace et les deux dernières représentations graphiques montrent l'insertion du coeur sur la feuille du trèfle..</p>				
EM	5264619	 <p>The trade mark</p>	3 4 5 11	Reckit Benckiser	E	2008

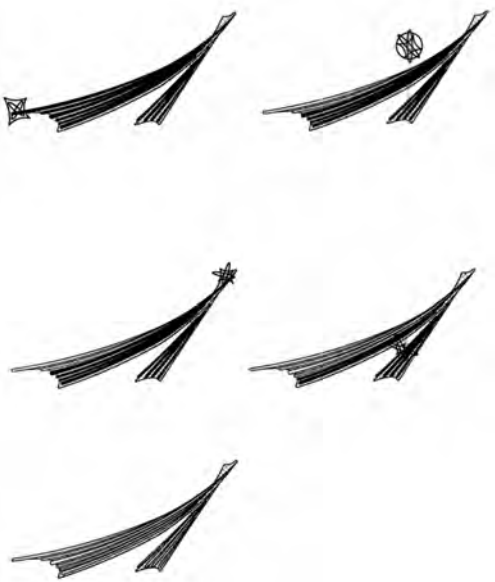
		consists a moving image of an animated octopus housewife character illustrated in the first frame of the sequence who is depicted in a family home, using her tentacles to perform multiple household tasks such as ironing, vacuuming, dusting, typing on a computer as represented in the sequence of still pictures attached				
EM	5280607	 <p>La protection de la marque est demandée pour l'enchaînement des couleurs successives aux reflets lumineux du logo imprimé sur un vêtement ou accessoire</p>	18 25	Raymont Morel	E W	2007
EM	5280623	 <p>La protection de la marque est demandée pour l'enchaînement des couleurs successives aux</p>	18 25	Raymond Morel	E W	2007

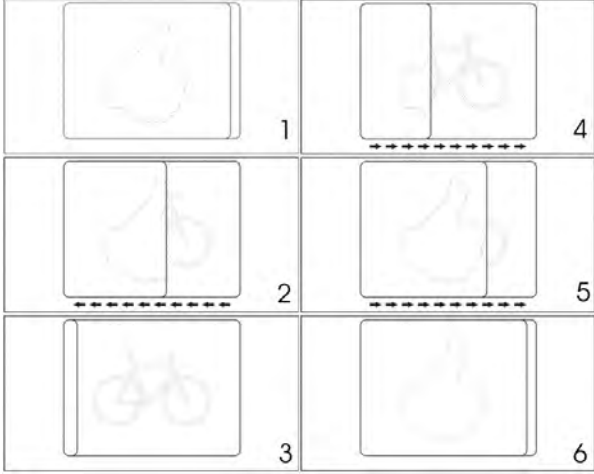
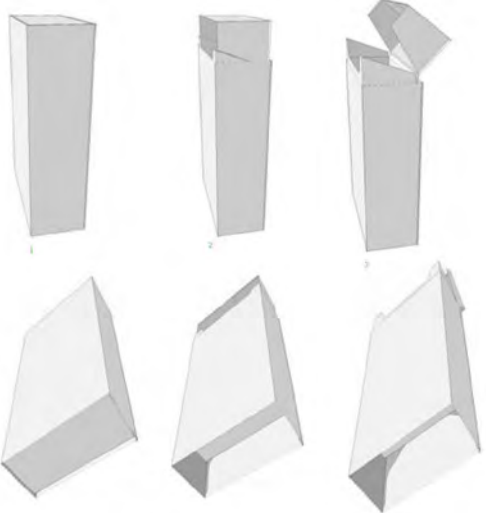
		reflets lumineux du logo imprimé sur un vêtement ou accessoire				
EM	5338629	 <p>Die Marke ist eine animierte Sequenz mit zwei Lichtelementen, die sich im oberen rechten Teil der Marke verbinden. Während der Animationssequenz bewegt sich ein geometrisches Objekt neben dem ersten Segment nach oben und dann neben dem zweiten Segment nach unten, während bei einzelnen Bändern in jedem Segment ein Wechsel von dunkel zu hell erfolgt. Die in der Marke befindliche Tupfentechnik dient nur der Schattierung. Die gesamte animierte Sequenz dauert zwischen einer und zwei Sekunden / The mark is an animated sequence with two flared segments that join in the upper right portion of the mark. During the animation sequence, a geometric object moves up adjacent the first segment and then down adjacent the second segment, while individual chords within each segment turn from dark to light. Stippling shown in the mark is for shading only..</p>	9	Microsoft Corp	R	2007

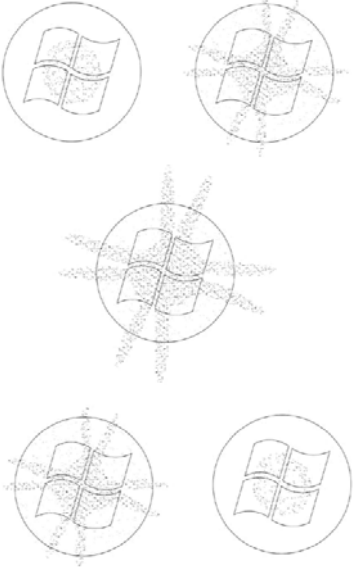
EM	5375886	 <p>Specification only available in Polish</p>	9 16 35 38 41	Netmore sp z.o.o.	E	2008
EM	5505896	 <p>Le mouvement porte sur un réceptacle comprenant deux parties montées coulissantes l'une dans l'autre. Le mouvement se caractérise par un coulisement s'achevant par le brusque basculement d'un élément situé sur une portion de la partie du réceptacle qui est extraite..</p>	16 34	PhilipMorris Product S.A.	E	2008

EM	5636113	 <p>The mark is an animated sequence featuring a flag image with a circle background, which illuminates during the animated sequence; the attached representation depicts five freeze frames, numbered 1 - 5 showing various points in the animated sequence; the illumination is depicted by the stippling in the representation; the length of the animated sequence is approximately 3 seconds..</p>	9	Microsoft Corp.	E	2008
EM	5692645	 <p>. The trademark</p>	16	Georgia Pacific S.A.	E W	2007

		consists of a sequence of animated images representing: images from 1 to 2: in a fakir academy young boys are training hard to become fakirs; images from 3 to 5: suddenly, an unhappy master storms into the classroom; he discovers that a boy has been hiding a roll of toilet paper and he confiscates it; pleasures like toilet paper are forbidden in the academy; images from 6 to 8: the master is in the men's room and he is secretly using the confiscated toilet paper for himself; he closes his eyes and smiles in happiness; images from 9 to 10: a paper roll is unrolling in a straight line from the left to the right on a paper pattern background				
EM	5692652	 <p>The trademark consists of a sequence of animated images representing: images from 1 to 2: the police are searching for a man who disappeared while he was in the garden mowing the lawn; image 3: the worried wife of the missing man is talking to the police; image 4: policeman is wondering what happened and where the husband is; image from 5 to 7: all along the missing husband has been asleep on the toilet seat with his head resting on the toilet paper roll; images from 8 to 9: a paper roll is unrolling in a straight line from the left to the right on a paper pattern background</p>	16	Georgia Pacific S.A	E W	2007

EM	56924661	 <p data-bbox="472 683 1256 1086">. The trademark consists of a sequence of animated images representing: images from 1 to 2: in a fakir academy the students are training hard to become fakirs; image 3: a man comes to deliver mail to the students from their families and gives a large parcel to a student; image 4: the boy opens his parcel and he is happy to find rolls of toilet paper in it; image 5: the teacher catches the boy with toilet paper rolls; he is angry because the fakir academy forbids such pleasures as toilet paper; image from 6 to 7: the teacher confiscates the parcel with toilet paper rolls from the student; he secretly uses the toilet paper for himself and walks away with a tail of toilet paper stuck in the back of his trousers; images from 8 to 9: a paper roll is unrolling in a straight line from the left to the right on a paper pattern background</p>	16	Georgia Pacific S.A.	E W	2007
----	----------	--	----	----------------------	-----	------

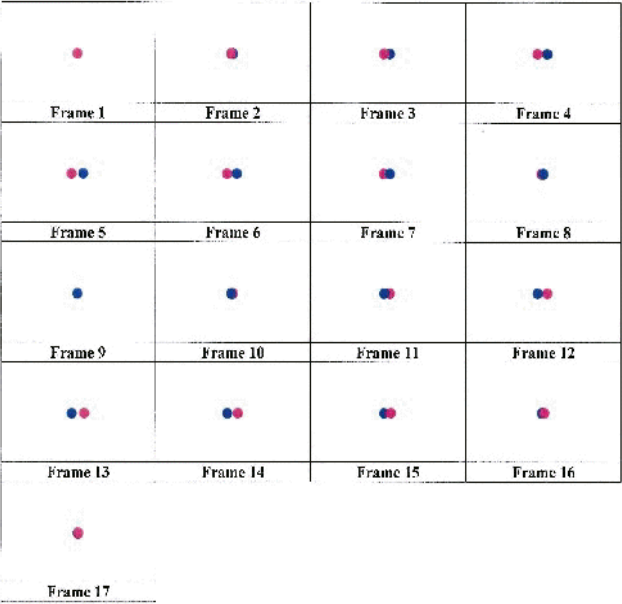
EM	5736822	<p style="text-align: center;">ANIMATED MISCELLANEOUS DESIGN MARK</p>  <p style="text-align: center;">Besteht aus einem sich bewegendem Bild aus einer animierten Bildfolge,</p>	9 35 38 40 41 42	Yahoo!	E	2008
----	---------	---	---------------------	--------	---	------

		<p>die zu Beginn aus einem rosa Kreis (PMS 226) besteht, wo ein blauer Kreis (PMS 3005) hinter dem rosa Kreis erscheint und sich nach rechts bewegt, bis er vom rosa Kreis getrennt ist. Dann beginnt er sich zurück zum rosa Kreis zu bewegen, um ihn zu verdunkeln, dann bewegt er sich weiter nach links vom rosa Kreis weg, bis er keinen Teil des rosa Kreises mehr verdunkelt, dann bewegt er sich waagrecht wieder zurück hinter den rosa Kreis, bis er verdunkelt ist. Die Zeichnung besteht aus 17 die animierte Bildfolge bildenden Bildern (oder Rahmen). Die Bewegung erfolgt mit einer Geschwindigkeit von 0,0588 Sekunden/Einzelbild, sodass die gesamte Bildfolge von Anfang bis Ende in 1 Sekunde abgeschlossen ist. / The mark comprises a moving image consisting of an animated visual sequence initially comprising a pink circle (pms 226), where a blue circle (pms 3005) appears from behind the pink circle and moves to the right until it is separate from the pink circle. It then begins to move back across the pink circle to obscure it, it then proceeds to move to the left of the pink circle until it does not obscure any part of the pink circle, it then moves horizontally back behind the pink circle until it is obscured. The drawing consists of seventeen stills (or frames) that make up the animated sequence. Movement occurs at a speed of .0588 second/frame, the entire sequence completing from start to finish within 1 second's time.</p>				
--	--	--	--	--	--	--

EM	5770466	 <p data-bbox="470 813 1265 1356">Gegenstand der Markenmeldung ist eine Bewegungsmarke, namentlich die Darstellung einer Folge von bewegten Bildern. Die Marke zeigt die graphische Darstellung in verschiedenen Perspektiven von einem, sich öffnenden Stifтетui. Dabei beginnt die erste Darstellung mit dem geschlossenen, transparenten Kunststoffteil und zeigt in den Bildern 2-5 den Öffnungsvorgang. Bild 6 zeigt das vollständig geöffnete Etui in seiner Funktion als Stiftehalter. Bei der Marke handelt es sich um den Bewegungsablauf von sechs Bildern (Darstellung 1 bis Darstellung 6 gemäß graphischer Wiedergabe), wobei diese in aufsteigender Reihenfolge ohne dazwischen liegende Pause gezeigt werden. Die einzelnen, in Bild 1 bis Bild 6 gezeigten Darstellungen, werden für folgende Zeitdauer gezeigt: Bild 1 zehn Sekunden; Bild 2 zwei Sekunden; Bild 3 zwei Sekunden; Bild 4 zwei Sekunden; Bild 5 zwei Sekunden; Bild 6 zehn Sekunden</p>	16 17 20	J.S. Staedtler GmbH & Co KG	E W	2007
----	---------	--	----------	-----------------------------	-----	------

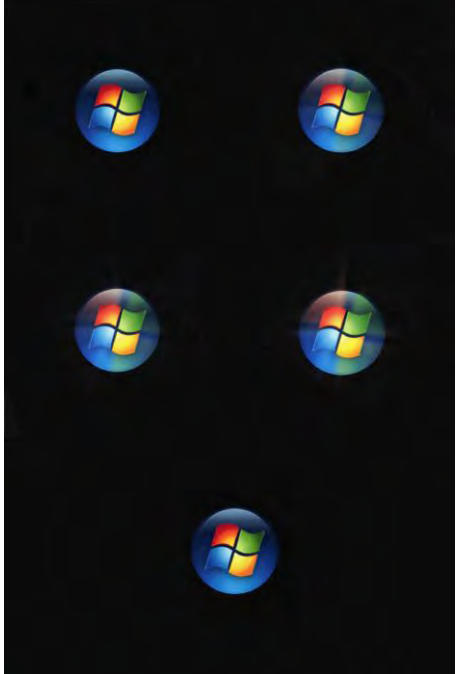

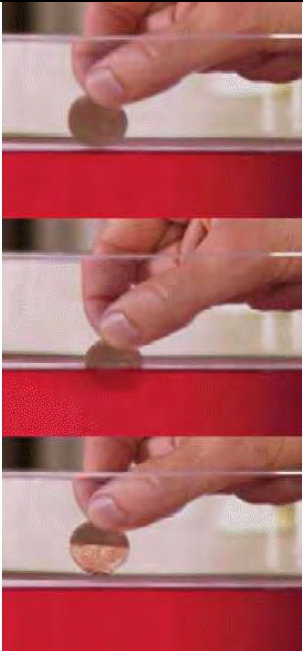
EM	5881628	 <p data-bbox="472 480 1249 660">Gegenstand der Marke ist der durch die Bildfolge wiedergegebene Bewegungs-ablauf. Die Bilder zeigen Ausschnitte eines kontinuierlichen Bewegungsablauf / The object of the trademark is the movement cycle represented by the sequence of images. The images show excerpts of a continuous movement cycle</p>	16 35 36 38 41 44	IKK <u>D</u> irekt	E R	2008
EM	5910831	 <p data-bbox="936 1318 1144 1350">Besteht aus einer</p>	9	Microsoft Corporation	E R	2008

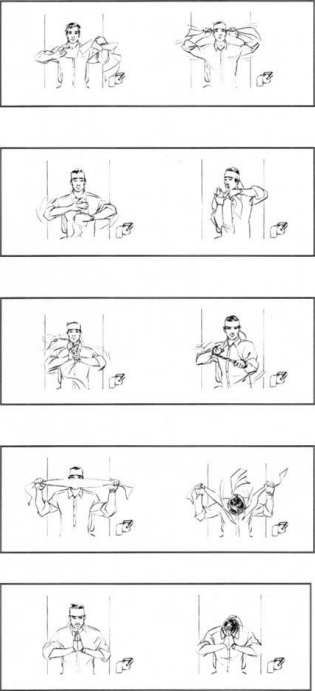
		animierten Sequenz mit dem Bild einer Flagge in einem Kreis als Untergrund, der während der Animation leuchtet. Beigefügte Abbildung zeigt fünf Standbilder, die von Nummer 1 bis 5 verschiedene Punkte der animierten Sequenz wiedergeben. Die Dauer der animierten Sequenz beträgt etwa drei Sekunden. / The mark is an animated sequence featuring a flag image with a circle background, which illuminates during the animated sequence. The attached representation depicts five freeze frames, numbered 1 to 5 showing various points in the animated sequence. The length of the animated sequence is approximately three seconds				
EM	5952999	 <p>Besteht aus dem sich bewegenden Bild einer Hand mit einer Münze zwischen Zeigefinger und Daumen, die in eine Flüssigkeit getaucht und wieder herausgenommen wird.. / The trade mark consists of a moving image of a hand with a coin between forefinger and thumb being dipped into a liquid and removed..</p>	3	Reckit Benkiser B.V.	R	2008

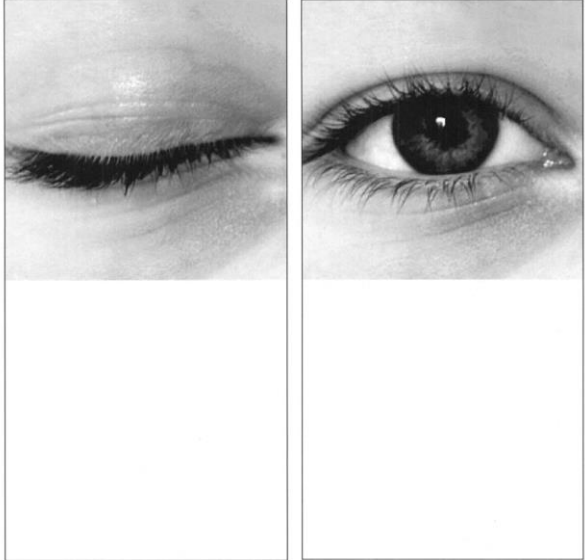
EM	62546515	 <p data-bbox="472 836 1274 1348">. The trademark consists of a sequence of animated images representing: Image 1: a man is sitting on a toilet bowl and holding a toilet paper roll in his right hand. He pulls the toilet paper sheets and unrolls a long strip of toilet paper. He puts it around his head and ties it at the back of his head. Image 2: the same man ties strip of toilet paper round his right hand. He keeps his right hand vertically and he continues wrapping it up in paper. Image 3: the same man twists in his hands a nunchaku of toilet paper. He stands in Kung fu fighting position with his nunchaku. Image 4: the same man stretches a stripe of toilet paper between his two hands and keeps it in front of his face. He bangs his head on the paper stripe and cuts it in two parts. Image 5: the same man closes his eyes and puts his hands together in front of him. He bows his head down</p>	16	Georgis Pacific S.A.	E W	2008
----	----------	--	----	----------------------	-----	------

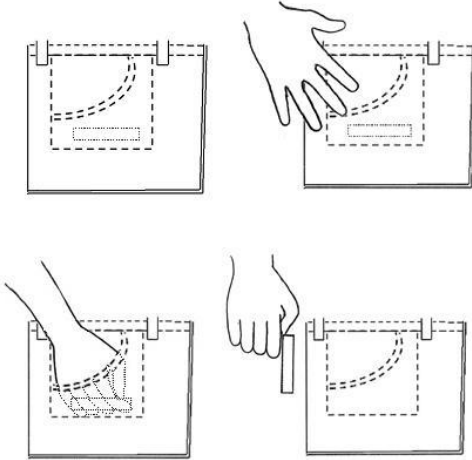
EM	6608962	 <p>The mark consists of an animated sequences of images that start with an infinity symbol traveling away from the viewer, which is then quickly transformed into a stylized form of HISAMITSU while a series of vertical blue bars originating in the infinity symbol move quickly both to the right and to the left of the infinity symbol. During this sequence, in the background, a larger infinity symbol moves and fades away..</p>		Hisamitsu Pharmaceutical Co Inc	R	2008
EM	6743587		9 16 35	Originize IP AG	E W	2009

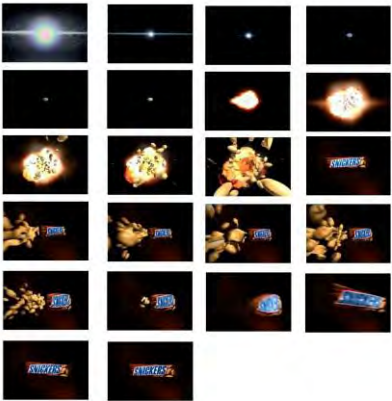

EM	6874911	 <p data-bbox="472 683 1274 1117">The trademark consists of a fortune cookie fortune, that is, a rectangular piece of paper roughly 6 cm in length by 2 cm in breadth, placed inside the front pocket of a pair of jeans. The paper is felt when placing one's hand inside the pocket and can also be withdrawn from the pocket to be visually perceived. In the pictorial representation of the trademark: interrupted lines indicate items that are not part of the trademark (such as the outline of the jeans and the pocket); dotted lines indicate items shown but not in fact visible (such as the hand and label inside the pocket); and full lines indicate the hand and the label outside the pocket..</p>	25	Lucky brand Dungarees	E W	2009
----	---------	---	----	-----------------------	-----	------

EM	007227218		9 35 38 41 42	HULU LLC	E W	2009
EM	008195992	 <p style="text-align: right;">Bewe</p> <p>gte Marke, bestehend aus Folgendem: Von der Bildschirmmitte geht zunächst helles weißes Licht aus, und anschließend wird der gesamte Bildschirm von zwei farbigen rotierenden Lichtern bedeckt, die in Blau und Gelb funkeln. Danach wird die rotierende gelbe und blaue Lichterscheinung kleiner und erscheint als ein einziges helles Licht, dass sich anschließend wieder in Blau und Gelb über den Bildschirm ergießt. Während die farbige Lichterscheinung auf dem Bildschirm kleiner wird, erscheint im Hintergrund die Wortgruppe SONY make.believe und wird immer besser und deutlicher sichtbar, wobei das Licht gleichzeitig zu einem einzigen Spotlight schrumpft und einen</p>	9 28 35 37 38 41 42 45	Sony Corporation	R	2010

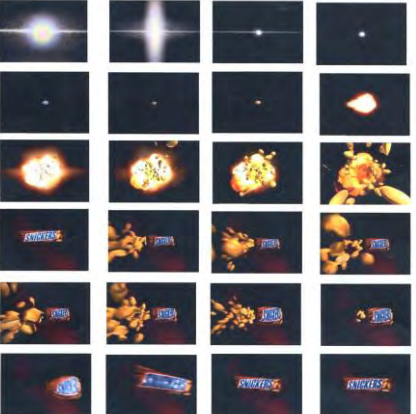
		<p>Punkt zwischen den Wörtern "make" und "believe" bildet. Die angefügten Zahlen 1-10 geben die Reihenfolge der Einzelbilder an, die diese Marke darstellen, und sind nicht Bestandteil der Marke. The trade mark is a moving trade mark comprising the following: Bright white light diffuses from the centre of the screen, with the whole screen then being covered by two coloured rotating lights, that are sparkling in blue and yellow. The yellow and blue rotating light burst decreases in size to appear as one bright light which then bursts across the screen again in blue and yellow. As the colour burst decreases in size on the screen, in the background the words SONY make.believe appear and become more visible and prominent as the light decreases into a single spotlight to form the full stop between the words "make" and "believe". The numbers 1-10 attached indicate the order of the frames whereby this trade mark is represented and are not part of the trade mark.</p>				
EM	08205247		29 30	Mars, Incorporated	E W	2010

EM	8207094		30	Mars, Incorporated	E W	2010
EM	8207532	 <p data-bbox="472 1062 1256 1383">Besteht aus einer animierten, etwa fünf Sekunden dauernden Abfolge aus 24 Standbildern, wobei sich zunächst ein heller Lichtblitz zu einem waagerechten weißen Lichtstrahl mit rundem Kern wandelt, der daraufhin zu einem einzelnen blauen Lichtfleck wird, welcher sich in eine einzelne Erdnuss verwandelt. Diese Erdnuss explodiert und verwandelt sich in einen Feuerball, aus dem mehrere Erdnüsse herausgeschleudert werden. Man sieht mehrere Erdnüsse in Richtung</p>	29 30	Mars, Incorporated	R	2010

		<p>Verpackung eines SNICKERS-Riegels wandern, die Verpackung erscheint in der Bildschirmmitte. Die SNICKERS-Verpackung füllt sich mit Erdnüssen, wird dabei größer und bewegt sich auf die rechte Seite des Bildschirms, bis die letzte Erdnuss in die SNICKERS-Verpackung gelangt ist. Die Verpackung wird größer, nimmt eine viereckige Form an und bewegt sich von der rechten Bildschirmseite zur Mitte.. The trade mark is an animated sequence consisting of twenty four stills that make up the sequence changing within a time frame of approximately five seconds from an intense flash of light, which changes into a horizontal ray of white light with a round (nucleus) centre transforming into a single blue light, which in turn is transformed into a single peanut, the single peanut explodes and is enveloped in a fireball, multiple peanuts are thrown outwards from the centre of the fireball, multiple peanuts are shown travelling towards the side of a SNICKERS bar wrapper, the wrapper appearing at an angle in the centre of the screen, the SNICKERS wrapper expands as it becomes filled with the peanuts and is moved towards the right of the screen, once the last peanut has entered the SNICKERS wrapper, the wrapper expands and then contracts in shape returning to a rectangular shape, moving from the right of the screen back to the centre.</p>				
--	--	---	--	--	--	--

EM	8361727		3 5 21	The procter & Gamble Co	R	2009
EM	8553133	 <p data-bbox="474 932 1249 1380">Besteht aus einer Zeichentrickbildfolge, die mit vier Objekten aus farbigem Licht beginnt (je eines in den Farben Rot, Grün, Gelb und Blau), die in einer versetzten Folge erscheinen und in genauen Bögen umeinander wirbeln, sich vergrößern und ihre Leuchtkraft verstärken, bis sie ineinanderfließen und eine vierteilige Flagge mit einem mit unterschiedlicher Leuchtkraft pulsierenden runden weißen Licht in der Mitte bilden. Die Zeichentrickbildfolge ist insgesamt etwa sieben Sekunden lang. / The mark consists of an animated sequence that begins with four objects of colored light (one each in the color red, green, yellow and blue) that appear in a staggered sequence and swirl around one another in distinct arcs, expanding in size and illumination intensity</p>	9	Microsoft Corporation	R	2010

		until they converge and form a four paneled flag image with a circular white light in the center that oscillates with varying illumination intensity. The total length of the animated sequence is approximately seven seconds.				
EM	8581911	 <p>Bewegte Marke in Farbe, die Bewegung ist die eines losen Bandes von schimmerndem Aussehen ("Band"), das Band flattert und nimmt schließlich eine kugelförmige Gestalt an ("Kugel"), die Dauer der Bewegung beträgt etwa 6 Sekunden, die Standbilder in der Sequenz liegen etwa 0,3 Sekunden auseinander, sie haben vom Beginn bis zum Ende der Sequenz den gleichen Abstand, das erste stehende Bild ist das oben links, das letzte (zwanzigste) ist das mittlere in der untersten Reihe, die Standbilder verlaufen in jeder Reihe von links nach rechts, bevor zur nächsten Reihe übergegangen wird, die genaue Sequenz der Standbilder ist folgende: Im ersten Standbild tritt das Band an der Oberkante des Rahmens in den Rahmen ein und flattert am rechten Bildrahmen abwärts, ehe es sich in den Standbildern 2 bis 6 wieder nach oben bewegt, während dieser Bewegungsphase (im vierten Standbild) sieht man das Ende des Bandes, so dass der Effekt eines nachgeführten Bandes entsteht, in den Standbildern 6 bis 17 weht das Band um den Rahmen entgegen dem Uhrzeigersinn, ab Bild 9 bewegt sich die Kugel unmittelbar in die Mitte des Rahmens, das Innere der Kugel hat die</p>	9 38 41	Sony Ericsson Mobile Mobile Communications	R	2011

		gleiche Farbe wie das Band, das Band flattert um die Kugel herum, in Bild 14 dringt das Band in die Kugel ein, als würde sie hineingezogen, in den Bildern 15 bis 17 verschwindet das Band in der Kugel, in den Bildern 19 und 20 bewegt sich die Kugel auf den Betrachter zu, gewinnt an Größe, und die Bewegung endet				
EM	8581977	 <p>Bewegte Marke in Farbe, die Bewegung ist die eines losen Bandes von schimmerndem Aussehen ("Band"), das Band flattert und nimmt schließlich eine kugelförmige Gestalt an ("Kugel"), die Dauer der Bewegung beträgt etwa 6 Sekunden, die Standbilder in der Sequenz liegen etwa 0,3 Sekunden auseinander, sie haben vom Beginn bis zum Ende der Sequenz den gleichen Abstand, das erste stehende Bild ist das oben links, das letzte (zwanzigste) ist das mittlere in der untersten Reihe, die Standbilder verlaufen in jeder Reihe von links nach rechts, bevor zur nächsten Reihe übergegangen wird, die genaue Sequenz der Standbilder ist folgende: Im ersten Standbild tritt das Band an der Oberkante des Rahmens in den Rahmen ein und flattert am rechten Bildrahmen abwärts, ehe es sich in den Standbildern 2 bis 6 wieder nach oben bewegt, während dieser Bewegungsphase (im vierten Standbild) sieht man das Ende des Bandes, so dass der Effekt eines</p>	9 38 41	Sony Ericsson Mobile Mobile Communications	R	2011

		nachgeführten Bandes entsteht, in den Standbildern 6 bis 17 weht das Band um den Rahmen entgegen dem Uhrzeigersinn, ab Bild 9 bewegt sich die Kugel unmittelbar in die Mitte des Rahmens, das Innere der Kugel hat die gleiche Farbe wie das Band, das Band flattert um die Kugel herum, in Bild 14 dringt das Band in die Kugel ein, als würde sie hineingezogen, in den Bildern 15 bis 17 verschwindet das Band in der Kugel, in den Bildern 19 und 20 bewegt sich die Kugel auf den Betrachter zu, gewinnt an Größe, und die Bewegung endet.				
EM	8582207	 <p>Bewegte Marke in Farbe, die Bewegung ist die eines losen Bandes von schimmerndem Aussehen ("Band"), das Band flattert und nimmt schließlich eine kugelförmige Gestalt an ("Kugel"), die Dauer der Bewegung beträgt etwa 6 Sekunden, die Standbilder in der Sequenz liegen etwa 0,3 Sekunden auseinander, sie haben vom Beginn bis zum Ende der Sequenz den gleichen Abstand, das erste stehende Bild ist das oben links, das letzte (zwanzigste) ist das mittlere in der untersten Reihe, die Standbilder verlaufen in jeder Reihe von links nach rechts, bevor zur nächsten Reihe übergegangen wird, die genaue Sequenz der Standbilder ist folgende: Im ersten Standbild tritt das Band an der Oberkante des Rahmens in den Rahmen ein und flattert am rechten Bildrahmen abwärts, ehe es sich in den Standbildern 2 bis 6 wieder nach oben bewegt,</p>	9 38 41	Sony Ericsson Mobile Mobile Communications	R	2011

		während dieser Bewegungsphase (im vierten Standbild) sieht man das Ende des Bandes, so dass der Effekt eines nachgeführten Bandes entsteht, in den Standbildern 6 bis 17 weht das Band um den Rahmen entgegen dem Uhrzeigersinn, ab Bild 9 bewegt sich die Kugel unmittelbar in die Mitte des Rahmens, das Innere der Kugel hat die gleiche Farbe wie das Band, das Band flattert um die Kugel herum, in Bild 14 dringt das Band in die Kugel ein, als würde sie hineingezogen, in den Bildern 15 bis 17 verschwindet das Band in der Kugel, in den Bildern 19 und 20 bewegt sich die Kugel auf den Betrachter zu, gewinnt an Größe, und die Bewegung endet.				
EM	8582389	 <p>Bewegte Marke in Farbe, die Bewegung ist die eines losen Bandes von schimmerndem Aussehen ("Band"), das Band flattert und nimmt schließlich eine kugelförmige Gestalt an ("Kugel"), die Dauer der Bewegung beträgt etwa 6 Sekunden, die Standbilder in der Sequenz liegen etwa 0,3 Sekunden auseinander, sie haben vom Beginn bis zum Ende der Sequenz den gleichen Abstand, das erste stehende Bild ist das oben links, das letzte (zwanzigste) ist das mittlere in der untersten Reihe, die Standbilder verlaufen in jeder Reihe von links nach rechts, bevor zur nächsten Reihe übergegangen wird, die genaue Sequenz der Standbilder ist folgende: Im ersten Standbild tritt das Band an der Oberkante des Rahmens in den Rahmen ein</p>	9 38 41	Sony Ericsson Mobile Mobile Communications	R	2011

		<p>und flattert am rechten Bildrahmen abwärts, ehe es sich in den Standbildern 2 bis 6 wieder nach oben bewegt, während dieser Bewegungsphase (im vierten Standbild) sieht man das Ende des Bandes, so dass der Effekt eines nachgeführten Bandes entsteht, in den Standbildern 6 bis 17 weht das Band um den Rahmen entgegen dem Uhrzeigersinn, ab Bild 9 bewegt sich die Kugel unmittelbar in die Mitte des Rahmens, das Innere der Kugel hat die gleiche Farbe wie das Band, das Band flattert um die Kugel herum, in Bild 14 dringt das Band in die Kugel ein, als würde sie hineingezogen, in den Bildern 15 bis 17 verschwindet das Band in der Kugel, in den Bildern 19 und 20 bewegt sich die Kugel auf den Betrachter zu, gewinnt an Größe, und die Bewegung endet.</p>				
EM	8582504	 <p>Bewegte Marke in Farbe, die Bewegung ist die eines losen Bandes von schimmerndem Aussehen ("Band"), das Band flattert und nimmt schließlich eine kugelförmige Gestalt an ("Kugel"), die Dauer der Bewegung beträgt etwa 6 Sekunden, die Standbilder in der Sequenz liegen etwa 0,3 Sekunden auseinander, sie haben vom Beginn bis zum Ende der Sequenz den gleichen Abstand, das erste stehende Bild ist das oben links, das letzte (zwanzigste) ist das mittlere in der untersten Reihe, die Standbilder verlaufen in jeder Reihe von links nach rechts, bevor zur nächsten Reihe übergegangen wird, die genaue Sequenz</p>	9 38 41	Sony Ericsson Mobile Mobile Communications	R	2011

		<p>der Standbilder ist folgende: Im ersten Standbild tritt das Band an der Oberkante des Rahmens in den Rahmen ein und flattert am rechten Bildrahmen abwärts, ehe es sich in den Standbildern 2 bis 6 wieder nach oben bewegt, während dieser Bewegungsphase (im vierten Standbild) sieht man das Ende des Bandes, so dass der Effekt eines nachgeführten Bandes entsteht, in den Standbildern 6 bis 17 weht das Band um den Rahmen entgegen dem Uhrzeigersinn, ab Bild 9 bewegt sich die Kugel unmittelbar in die Mitte des Rahmens, das Innere der Kugel hat die gleiche Farbe wie das Band, das Band flattert um die Kugel herum, in Bild 14 dringt das Band in die Kugel ein, als würde sie hineingezogen, in den Bildern 15 bis 17 verschwindet das Band in der Kugel, in den Bildern 19 und 20 bewegt sich die Kugel auf den Betrachter zu, gewinnt an Größe, und die Bewegung endet.</p>				
EM	8582538	 <p>Bewegte Marke in Farbe, die Bewegung ist die eines losen Bandes von schimmerndem Aussehen ("Band"), das Band flattert und nimmt schließlich eine kugelförmige Gestalt an ("Kugel"), die Dauer der Bewegung beträgt etwa 6 Sekunden, die Standbilder in der Sequenz liegen etwa 0,3 Sekunden auseinander, sie haben vom Beginn bis zum Ende der Sequenz den gleichen Abstand, das erste stehende Bild ist das oben links, das letzte (zwanzigste) ist das mittlere in der untersten Reihe, die Standbilder verlaufen in jeder Reihe von links nach rechts, bevor zur</p>	9 38 41	Sony Ericsson Mobile Mobile Communications	R	2011

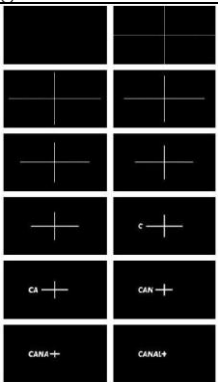

		nächsten Reihe übergegangen wird, die genaue Sequenz der Standbilder ist folgende: Im ersten Standbild tritt das Band an der Oberkante des Rahmens in den Rahmen ein und flattert am rechten Bildrahmen abwärts, ehe es sich in den Standbildern 2 bis 6 wieder nach oben bewegt, während dieser Bewegungsphase (im vierten Standbild) sieht man das Ende des Bandes, so dass der Effekt eines nachgeführten Bandes entsteht, in den Standbildern 6 bis 17 weht das Band um den Rahmen entgegen dem Uhrzeigersinn, ab Bild 9 bewegt sich die Kugel unmittelbar in die Mitte des Rahmens, das Innere der Kugel hat die gleiche Farbe wie das Band, das Band flattert um die Kugel herum, in Bild 14 dringt das Band in die Kugel ein, als würde sie hineingezogen, in den Bildern 15 bis 17 verschwindet das Band in der Kugel, in den Bildern 19 und 20 bewegt sich die Kugel auf den Betrachter zu, gewinnt an Größe, und die Bewegung endet.				
EM	8582595	 <p>This is a motion mark in colour. The nature of the motion is that of a trailing ribbon with a liquid-like appearance ("ribbon"). The ribbon flows around and ultimately into a sphere design ("sphere"). The duration of the motion is approximately 6 seconds. The stills in the sequence are spaced approximately 0.3 seconds apart. The stills are evenly spaced from the beginning to end of sequence. The 1st still is the upper left still. The last still (20th) is the middle still in the bottom row. The stills follow a progression from left to right within each row, before</p>	9 38 41	Sony Ericsson Mobile Mobile Communications	R	2011

		<p>moving down to the next row. The precise sequence of the stills is as follows: In the 1st still, the ribbon enters the frame in the upper edge of the frame and flows down the right edge of the frame, before flowing upward in the 2nd to 6th stills. During that phase of motion (in the 4th still) the end of the ribbon is shown, producing the effect of a trailing ribbon. In the 6th to 17th stills, the ribbon flows counter clockwise around the frame. From the 9th still onwards, the sphere immediately moves into the centre of the frame. The interior of the sphere is the same colour as the ribbon. The ribbon flows around the sphere. In the 14th still, the ribbon enters the sphere, as if being pulled inside. In the 15th to 17th stills, the ribbon disappears inside the sphere. In the 19th and 20th stills, the sphere moves toward the viewer, gaining in size and ending the motion.</p> <p>Bewegte Marke in Farbe, die Bewegung ist die eines losen Bandes von schimmerndem Aussehen ("Band"), das Band flattert und nimmt schließlich eine kugelförmige Gestalt an ("Kugel"), die Dauer der Bewegung beträgt etwa 6 Sekunden, die Standbilder in der Sequenz liegen etwa 0,3 Sekunden auseinander, sie haben vom Beginn bis zum Ende der Sequenz den gleichen Abstand, das erste stehende Bild ist das oben links, das letzte (zwanzigste) ist das mittlere in der untersten Reihe, die Standbilder verlaufen in jeder Reihe von links nach rechts, bevor zur nächsten Reihe übergegangen wird, die genaue Sequenz der Standbilder ist folgende: Im ersten Standbild tritt das Band an der Oberkante des Rahmens in den Rahmen ein und flattert am rechten Bildrahmen abwärts, ehe es sich in den Standbildern 2 bis 6 wieder nach oben bewegt, während dieser Bewegungsphase (im vierten Standbild) sieht man das Ende des Bandes, so dass der Effekt eines nachgeführten Bandes entsteht, in den Standbildern 6 bis 17 weht das Band um den Rahmen entgegen dem Uhrzeigersinn, ab Bild 9 bewegt sich die Kugel unmittelbar in die Mitte des Rahmens, das Innere der Kugel hat die</p>				
--	--	--	--	--	--	--

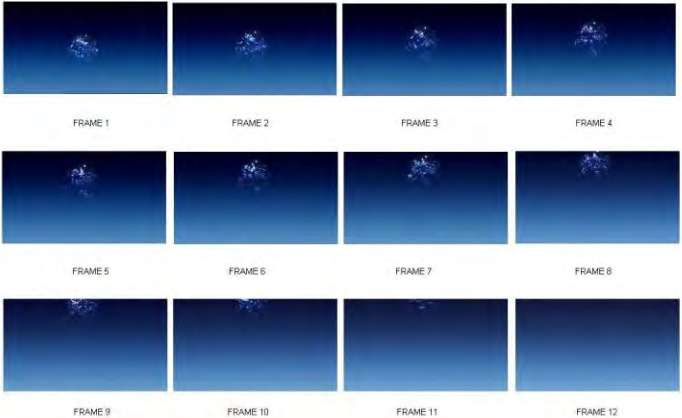
		gleiche Farbe wie das Band, das Band flattert um die Kugel herum, in Bild 14 dringt das Band in die Kugel ein, als würde sie hineingezogen, in den Bildern 15 bis 17 verschwindet das Band in der Kugel, in den Bildern 19 und 20 bewegt sich die Kugel auf den Betrachter zu, gewinnt an Größe, und die Bewegung endet.				
EM	8594566	 <p>This trademark consists of sequences of animated images that start with a black screen, followed by a screen divided into four equal black parts, delimited by two thin white bands, one horizontal and the other vertical, these bands becoming shorter towards the centre of the screen and becoming thicker, to form the "+" sign in white; at the same time as the reduction in size of the "+" sign, the following letters "C", "CA", "CAN", "CANA", "CANAL" appear gradually before the "+" sign, the screen eventually transforming into the stylised form CANAL+ in white characters on a black background.. / Besteht aus bewegten Bildfrequenzen, die mit einem schwarzen Bildschirm beginnen, gefolgt von einem in vier gleiche schwarze Bereiche geteilten Bildschirm, dessen Bereiche durch zwei dünne weiße Striche voneinander abgegrenzt sind, von denen einer waagrecht und der andere senkrecht verläuft, wobei diese beiden Striche zur Bildschirmmitte dünner werden und dicker werden, um so das weiße Zeichen "+" zu bilden,</p>	35 38 41	Canal + france	R	2010

		<p>parallel zu dieser Verkleinerung des Zeichens "+" erscheinen nacheinander die folgenden Buchstaben "C", "CA", "CAN", "CANA", "CANAL" vor dem Zeichen "+", und zuletzt verwandelt sich der Bildschirm in die stilisierte Form CANAL+, die in weißen Buchstaben auf schwarzem Grund dargestellt ist / Besteht aus bewegten Bildfrequenzen, die mit einem schwarzen Bildschirm beginnen, gefolgt von einem in vier gleiche schwarze Bereiche geteilten Bildschirm, dessen Bereiche durch zwei dünne weiße Striche voneinander abgegrenzt sind, von denen einer waagrecht und der andere senkrecht verläuft, wobei diese beiden Striche zur Bildschirmmitte dünner werden und dicker werden, um so das weiße Zeichen "+" zu bilden, parallel zu dieser Verkleinerung des Zeichens "+" erscheinen nacheinander die folgenden Buchstaben "C", "CA", "CAN", "CANA", "CANAL" vor dem Zeichen "+", und zuletzt verwandelt sich der Bildschirm in die stilisierte Form CANAL+, die in weißen Buchstaben auf schwarzem Grund dargestellt ist</p>				
EM	86668949	 <p>The mark comprises a moving image consisting of an animated visual sequence initially comprising a mnemonic bubble device centrally positioned on a graduated blue background and then the mnemonic bubble device</p>	<p>9 35 36 37 38 39 41 42 43 44 45</p>	O2 Holdings ltd	R	2010

		<p>gradually moves vertically until it disappears. The drawing consists of twelve stills (or frames) that make up the animated sequence. Movement occurs at a speed of 0.144 seconds between the first and second frame, 0.144 seconds between the second and third frame, 0.144 seconds between the third and fourth frame, 0.144 seconds between the fourth and fifth frame, 0.544 seconds between the fifth and sixth frame, 0.140 seconds between the sixth and seventh frame, 0.140 seconds between the seventh and eighth frame, 0.150 seconds between the eighth and ninth frame, 0.540 seconds between the ninth and tenth frame, 0.150 seconds between the tenth and eleventh frame, and 0.330 seconds between the eleventh and twelfth frame. The entire sequence completing from start to finish is 2.570 seconds / Enthält ein bewegtes Bild, bestehend aus einer animierten visuellen Sequenz, die die Abbildung einer mnemonischen Blase enthält, die sich zu Beginn in der Mitte eines Hintergrunds in abgestuften Blautönen befindet, anschließend bewegt sich die Abbildung einer mnemonischen Blase langsam in vertikaler Richtung, bis sie schließlich verschwindet. Das bewegte Bild besteht aus zwölf Standbildern (oder Bildern), aus denen sich die animierte Sequenz zusammensetzt. Die Bewegung erfolgt mit einer Geschwindigkeit von 0,144 Sekunden zwischen dem ersten und dem zweiten Bild, 0,144 Sekunden zwischen dem zweiten und dem dritten Bild, 0,144 Sekunden zwischen dem dritten und dem vierten Bild, 0,144 Sekunden zwischen dem vierten und dem fünften Bild, 0,544 Sekunden zwischen dem fünften und dem sechsten Bild, 0,140 Sekunden zwischen dem sechsten und dem siebten Bild, 0,140 Sekunden zwischen dem siebten und dem achten Bild, 0,150 Sekunden zwischen dem achten und dem neunten Bild, 0,540 Sekunden zwischen dem neunten und dem zehnten Bild, 0,150 Sekunden zwischen dem zehnten und dem elften Bild und 0,330 Sekunden zwischen dem elften und dem zwölften</p>				
--	--	---	--	--	--	--

		Bild. Die gesamte Sequenz vom Beginn bis zum Ende dauert 2570 Sekunden.				
EM	8679748	 <p>The mark consists of a motion sequence of 25 images depicting the EyePet character hiding behind the EYEPET TM word and slowly extending its tail, uncurling it and swinging it from right to left. / Besteht aus einer Bewegungssequenz von 25 Bildern, die die Figur EyePet darstellen, die sich hinter dem Wort EYEPET TM versteckt und langsam ihren Schwanz herausstreckt, ihn entfaltet und von rechts nach links schwingt.</p>	9 16 24 25 28 32	Sony Computer Entertainmant Europe Ltd	R	2010
EM	8833394	 <p>Besteht aus einer Serie von 7 Bildern, die eine Bewegung sequenziell anordnen, in deren Verlauf ein T-Shirt von einer Person gefaltet wird, bis es eine Ziffer 1 formt. La marque se compose d'une série de 7 images</p>	3	The Procter & Gamble Co	R	2010

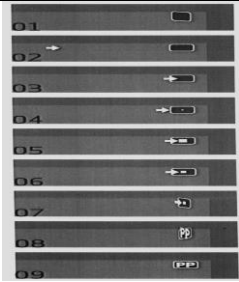
		représentant une séquence de mouvements où un t-shirt est plié par une personne jusqu'à ce qu'il forme le chiffre 1.				
EM	8840894	 <p>Dargestellt sind zur Beschreibung der Bewegungsmarke 9 Sequenzen, wobei die fortlaufende Nummerierung von oben nach unten die verschiedenen Stadien des Bewegungsablaufs wiedergeben. Gezeigt wird der Ausschnitt eines Bildschirms, in welchem sich in der rechten oberen Ecke das als Bewegungsmarke beantragte Logo hineindreht. Die Bewegungsmarke ist dabei eine Kombination aus Bewegungs- und Positionsmarke. Die Bewegungsmarke besteht im ersten Stadium (Bild 01 und 02) aus einem an den Ecken abgerundeten Rechteck mit umlaufendem hellen Rand, welches sich um die halbe eigene leicht schräg gestellte Achse drehend in die oberen rechten Ecke auf dem Bildschirm hineindreht und schließlich als Rechteck mit der größeren Seite parallel zur oberen Seite des Bildschirms in der oberen rechten Ecke auf dem Bildschirm verbleibt. Zu diesem Zeitpunkt ist von der linken oberen Seite des Bildschirms kommend ein in heller Farbe gestalteter Pfeil in Bewegung zu dem Rechteck zu sehen (Bild 02), der sich dem Rechteck nähert und schließlich das Rechteck an der linken Seite bis zu einem Drittel überdeckt (Bild 03). Sodann bewegt sich der Pfeil wieder in die entgegen gesetzte Richtung nach links, bis der Pfeil den äußeren Rand des Rechtecks erreicht hat (Bild 04). Etwa gleichzeitig erscheint in der Mitte des Rechtecks ein kleines Quadrat in heller Farbe, welches stetig größer wird, bis es etwa ein Drittel der</p>	9 38 41	Görg Rechtsanwälte	R	2010

		<p>Fläche des Rechtecks einnimmt. Während dieser Wachstumsphase bewegt sich der Pfeil wieder nach rechts bis er schließlich das Rechteck an der linken Seite bis zu einem Drittel überdeckt und an den Rand des Quadrates stößt (Bild 04 und 05). Nach Erreichen dieser Größe verkleinert sich das Quadrat wieder stetig, bis es etwa ein Viertel der Fläche des Rechtecks einnimmt. Der Pfeil bleibt an seiner Position (Bild 06). Sodann dreht sich das Rechteck wieder um die eigene leicht schräg gestellte Achse bis die Rückseite des Rechtecks erscheint. Der Pfeil verschwindet hinter der sich wendrehenden vormaligen Vorderseite des Rechtecks. Gleichzeitig erscheinen die nebeneinander angeordneten 2 Buchstaben PP in heller Farbe in etwa der Größe des Rechtecks, die - stetig etwas kleiner werdend - schließlich innerhalb des Logos und den Innenbereich nahezu vollständig einnehmend erscheinen und die neue Vorderseite des Rechtecks bilden (Bild 07 und 08). Das Logo verbleibt sodann ohne weitere Bewegung in dieser Position (Bild 09). / The trademark consists of 9 sequences describing the motion trademark, and the sequential number from top to bottom represents the different stages of the motion sequence. A section of a display screen is shown, containing in its upper right corner, the proposed logo for the motion trademark. The motion trademark is therefore a combination of a motion and positional trademark. In the first stage (image 01 and image 02), the motion trademark consists of a rectangle with rounded edges with a light coloured border, revolving 180 degrees around its own slightly tilted axis and attached to the upper right corner of the screen, which eventually becomes a rectangle in the upper right corner of the screen with the longer sides parallel to the upper side of the screen. At this juncture a light-coloured arrow appears from the upper left side of the screen pointing towards the rectangle (image 02), and moves closer, eventually covering up to a third of the left side of the rectangle (image 03). The arrow then moves to the</p>				
--	--	--	--	--	--	--

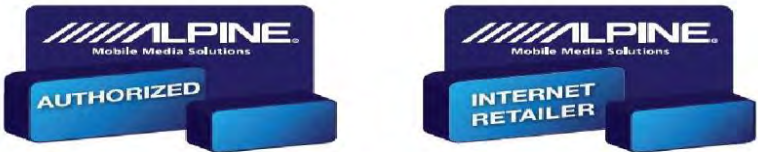
		<p>left in the opposite direction, until it reaches the outer edge of the rectangle (image 04). At the same time, a small, light-coloured square appears in the centre of the rectangle, becoming progressively larger until it covers almost a third of the area of the rectangle. While the square is getting bigger, the arrow moves once more to the right until it eventually covers up to a third of the left side of the rectangle and touches the edge of the square (image 04 and 05). After reaching this size, the square gets progressively smaller until it covers about a quarter of the area of the rectangle. The arrow remains in its position (image 06). The rectangle then turns again on its own slightly tilted axis until the rear side of the rectangle appears. The arrow disappears behind the revolving former front side of the rectangle. At the same time the two light-coloured letters PP appear, roughly the size of the rectangle and arranged next to one another, and, becoming progressively smaller, eventually appear to almost completely cover the logo and the interior and form the new front side of the rectangle (image 07 and 08). The logo remains in this position and there is no further movement (image 09).</p>				
EM	8846453	 <p>Besteht aus einer animierten Sequenz aus zwei Bildern mit einem Hintergrund, der das ALPINE-Logo mit den Worten Mobile Media Solutions enthält, und zwei Boxen im Vordergrund. Die große Box enthält im ersten Bild das Wort AUTHORIZED, das sich im zweiten Bild in das Wort INTERNET RETAILER verwandelt. / The mark consists of</p>	9	Alpine Electronics Inc	R	2010

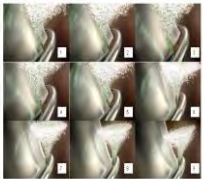
		an animated sequence of two images featuring a background containing the ALPINE logo with the words Mobile Media Solutions and two boxes in the foreground. The larger box contains the word AUTHORIZED in the first image which changes to the words INTERNET RETAILER in the second image.				
EM	8884447	 <p>the sign consists in a series of 4 pictures showing a movement whereby the main character is removing a layer of grey veil from the clothes that said character is wearing</p>	3	The Procter & Gamble Co.	E W	2010
EM	9125402	 <p>The sign consists in a series of 9 pictures showing a movement whereby a tornado is evolving on the edge of a dish and washing it energetically</p>	3	The Procter & Gamble Co.	E W	2010

EM	9125527	 <p>The sign consists in a series of 8 pictures showing a movement whereby a hand washing a dish with a sponge provokes the creation of a tornado, which evolves on the edge of the dish and cleans it energetically</p>	3	The Procter & Gamble Co	E W	2010
EM	9280108		4 7 21	Biouniversal	E W	2010
EM	9313438	 <p>Bewegungsmarke. (Deutsch): Bild 1: Beginn. Anfangsaufnahme. Allianz Adler Symbol. Bild 2: Symbol</p>	16 35 36	Allianz SE	E W	2010

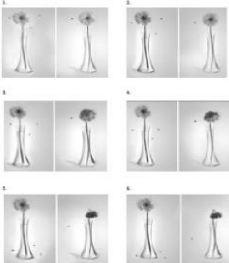
		verwandelt sich in einen Kenntnis/ Hinweis Notizblock. Bild 3: Es erscheint der Kenntnis/ Hinweis Notizblock				
EM	9333923	 <p>The trade mark consists of the moving image of two flowers. Each of the flowers is in a vase. In frame 1 both flowers are alive, upright and appear healthy. Flies surround the flowers. In frame 2 one of the flowers remains alive, upright and healthy. However, the head of the other flower is beginning to droop. In frame 3, one of the flowers is still alive, upright and healthy. However, the head of the other flower has drooped even more. One of the flowers is noticeably less healthy in appearance than the other. In frame 4 one of the flowers is still alive, upright and healthy. However, the other is now noticeably drooped and the head appears wilted and dying. In frame 5 one of the flowers is still alive, upright and healthy. The flies surrounding this flower now appear dead or dying. The other flower is wilted with its head hanging down. The fly around this flower is still alive. In the final frame one of the flowers is still alive, upright and healthy. The other flower is wilted and appears dead. The fly around this flower is still alive. (unclear)</p>	5 9 11	Reckitt & Colman	E W	2011

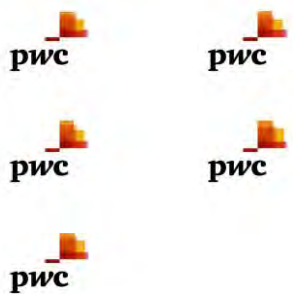
EM	9382946	 <p>The mark consists of a motion mark consisting of an animation sequence depicted in five freeze frames showing various points in the movement. The mark consists of the black stylized letters 'pwc' underneath a geometric design formed by a series of five overlapping squares and rectangles connected in the bottom left corner to a single short rectangle. The colors used within the symbol are dark burgundy, dark red, brown, dark orange, orange, light orange, pink, red, yellow, and beige. The dark burgundy color also appears in the short single rectangle that does not overlap any of the other shapes. During the animation sequence, each of the five overlapping squares and rectangles move horizontally and vertically in different directions, growing larger and smaller in size, and change color as they overlap with each other. The animation sequence begins at the top left freeze frame and progresses left to right, top to bottom, until the mark returns to its original format shortly after the last frame shown</p>	9 16 35 36 41 42 45	PWC Business Trust	E W	2011
----	---------	--	---------------------------	--------------------	-----	------

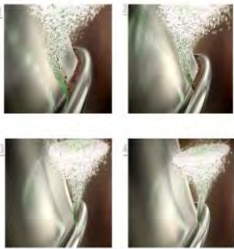
EM	9557422	 <p>The sign consists in a series of 14 pictures showing a movement whereby the main character is removing a layer of grey veil from the clothes that said character is wearing</p>	3	The Procter & Gamble Co.	E	2011
EM	9596289	 <p>The sequence shows the motion of a tornado caused by the action of a dish detergent cleaning out the dirt of a pan turned upside down. The tornado motion starts on the picture „1“, where the detergent (represented in green) is still pure. In the pictures that follow the dirt (represented in brown) mixes up with the detergent and the tornado is seen moving around the border of the pan from the left to the right (anti-clockwise). It is possible to notice that while funnel of the tornado gets thinner, the cloud becomes more concentrated. From one picture to the other it is also possible to notice the gradual removal of the dirt from the border of the pan. The tornado motion sequence (from picture 1 to 4) happens very fast and lasts less than 3 seconds.</p>	3	The Procter & Gamble Co.	E R	2011

EM	9661299		35	Woot int	R	2011
EM	9742974		21	Lingner Production	E W	2011
EM	9784431		30 35	I.D.C. Polonia SA	R	2011

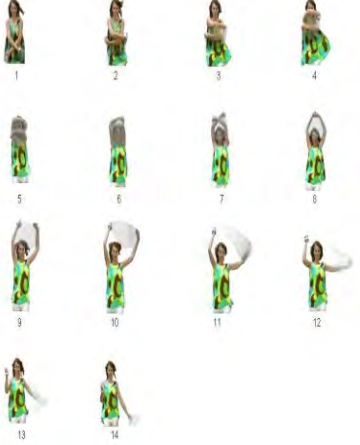
EM	10084507	 <p data-bbox="472 624 1256 1358">Diese Marke besteht aus einer Bewegungsabfolge von Bildern in Farbe. Die Bewegung besteht darin, dass die agierende Figur einen grauen Schleier langsam über ihre Kleidung bis ganz über ihren Kopf hebt. Die Bewegung führt dazu, dass besagter grauer Schleier, ursprünglich Teil der Kleidung, vollständig abgezogen und entfernt werden kann. Die Dauer der Bewegung beträgt etwa zwei Sekunden. Die 14 Standbilder der Sequenz folgen in einem Abstand von etwa 0,14 Sekunden aufeinander. Das erste Standbild ist links oben dargestellt. Das letzte Standbild (Nr. 14) ist das letzte in der vierten Reihe. Die präzise Abfolge der Bilder lautet: in Standbild 1 ergreift die Figur den grauen Schleier an der Kleidung. In den Standbildern 2 bis 4 zieht die Figur den grauen Schleier von der Oberkleidung ab. In den Standbildern 5 bis 9 entfernt die Figur den grauen Schleier vom Oberkörper, nämlich von Kopf und Schultern. In den Standbildern 10 bis 14 wird die Bewegung vollendet und der graue Schleier vollständig entfernt. / This is a motion mark in colour. The nature of the motion is that of a main character slowly removing a grey veil from its clothing and passing it over its head to remove it completely. The nature of the motion perceived is that this grey veil, which had been a part of the initial clothing, can be peeled off and removed entirely. The duration of the movement is approximately 2 seconds. The 14 stills in the sequence are spaced approximately 0.14 seconds apart. The 1st</p>	3	The Procter & Gamble Co	R	2012
----	----------	--	---	-------------------------	---	------

		<p>still is the upper left still. The last still (14th) is the second still on the 4th row. The precise sequence of the stills is as follows: in still 1 the main character catches the grey veil from its clothing. In stills 2 to 4, the main character peels the grey veil off from its upper clothing. In stills 5 to 9, the main character removes the grey veil from the upper part of its body, namely its head and shoulders. In stills 10 to 14, the main character finalizes this removal. At the end of the motion the grey veil has been completely removed.</p>				
EM	10108322	 <p>Bewegungsmarke in Form einer animierten Bildsequenz, die eine unregelmäßige Blasenform, bestehend aus rosa konzentrischen Linien, in Kombination mit der unten rechts angeordneten</p>	9 35 38 41	ITV Studios Ltd	R	2011

		<p>Wortgruppe "ITV Studios" in Grau auf schwarzem Grund zeigt. Durch eine wogende Abfolge von Falten und Wellen kräuseln sich die Konturen der Blasenform in einem Bewegungsablauf wie bei wehendem Stoff, der von rechts unten durch einen Ventilator angeblasen wird. Der Fokus der Linien nimmt zu, wobei die konzentrische Blasenform insgesamt erhalten bleibt. Während die Kräuselbewegungen der konzentrischen Linien im Bewegungsverlauf zunehmend tiefere Falten und Wellen bilden, schlägt die Farbe der äußeren Linien allmählich von Rosa in Blau um, und die anfangs grau erscheinende Wortgruppe "ITV Studios" leuchtet zunehmend heller auf, bis sie am Ende weiß ist. Die konzentrischen Linien bewegen sich weiter in tieferen Falten und Wellen, und währenddessen breitet sich der blaue Farbton der äußeren Linien immer weiter nach innen aus, und die endgültige unregelmäßige Form aus bunten Linien flattert nach außen, wobei die Linien in der Mitte hellrosa sind, dann allmählich in Violett übergehen und am Außenrand schließlich hellblau sind. Die Gesamtlänge der animierten Bildsequenz beträgt 6 Sekunden /</p> <p>Movement mark. The trade mark is an animated sequence consisting of an irregular bubble shape composed of pink concentric lines in conjunction with the words "ITV Studios" in grey in the bottom right hand corner on a black background. The contours of the bubble shape ripple through an undulating series of folds and waves with a movement similar to the movement of fabric fanning from the bottom right. The focus of the lines increase whilst an overall concentric bubble shape is maintained. As the ripple movements of the concentric lines progressively form deeper folds and waves, during the course of the ripple movement, the outer lines gradually change colour from pink to blue and the wording "ITV Studios" progressively brightens from grey to white. The concentric lines continue to move in deeper folds and waves as the blue shading of the outer lines progresses inwards and as the final irregular shape of coloured lines fans outwards, with bright pink lines at the centre blending into purple lines and then bright blue lines at the outer edges. The total length of the animated sequence is 6 seconds</p>				
--	--	---	--	--	--	--

EM	10143105	 <p data-bbox="472 624 1263 1356">Dies ist eine Bewegungsmarke in Farbe. Besteht aus einer animierten Sequenz einer menschlichen Hand, die in einem Schrank hängende Kleidungsstücke berührt und eine unregelmäßige Anzahl farbiger Blitze in Form verschieden großer Kreise erzeugt. Die Dauer dieser Bewegung beträgt etwa 2 Sekunden. Die 11 Stillbilder der Sequenz jeweils im Abstand von rund 0,18 Sekunden hintereinander angeordnet. Das 1. Bild befindet sich oben links, das letzte (11.) unten rechts. Die genaue Reihenfolge der Stillbilder ist vom 1. bis zum 11.. Die Hand bewegt sich von rechts nach links in einer horizontalen Linie und verursacht Wellen in der hängenden Kleidung, während sich die farbigen Kreise in entgegengesetzte Richtung, von links nach rechts, bewegen und ihre Menge sich mit dem Fortschreiten der Bewegung erhöht. / This is a motion mark in colour. The trademark consists in an animated sequence of a human hand's touch of clothes hanging in a closet generating an irregular number of coloured sparkles in the form of various sized circles. The duration of the movement is approximately 2 seconds. The 11 stills in the sequence are spaced approximately 0.18 seconds apart. The 1st still is the upper left still. The last still (11th) is on the bottom right. The precise sequence of the stills is as follows: from the 1st still to the 11th still, the movement of the hand is from right to left in a horizontal line creating ripples in the hanging clothing while the coloured</p>	3	The Procter & Gamble Co	R	2012
----	----------	--	---	-------------------------	---	------

		<p>circled sparkles move, in the opposite direction, from left to right, increasing in quantity as the movement moves forward.</p>				
EM	10393023	 <p>Besteht aus einer 19 Sekunden dauernden animierten Sequenz, bestehend aus achtzehn Dias, die in einem Zeitabstand von zirka einer Sekunde wechseln, diese Sequenz beginnt mit einem rechteckigen schwarzen Bildschirm, auf dem senkrechte Lichtstrahlen erscheinen, die in wechselnder Intensität und Farbe projiziert werden, diese Lichteffekte werden zunächst intensiver und danach wieder zunehmend schwächer, bevor sie völlig verschwinden, gleichzeitig erscheint allmählich die Bezeichnung "STUDIOCANAL" in Intervallen ("SS", "STU", "STUDIO", "STUDIOCANAL") von links nach rechts und im Hintergrund zunächst verschwommen und flüchtig, danach rollt sie durch flüchtige Spiegel- und Lichteffekte ab, bis sie vollständig im Vordergrund und in der Mitte des Bildschirms angekommen ist, sie besteht aus weißen,</p>	9 16 25 35 38 41 42	Groupe canal +	R	2012

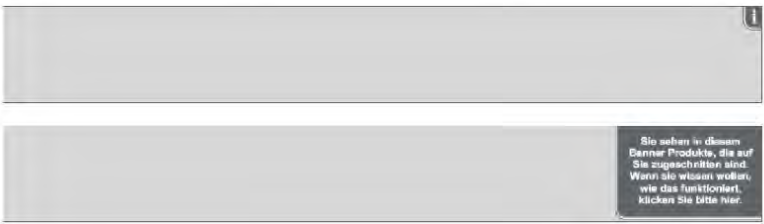
		<p>in fetter Schrift gestalteten Großbuchstaben, die sich zunächst in einem schwarzen Kästchen und am Ende nur noch auf schwarzem Grund befinden. The trademark consists of an animated sequence of nineteen seconds composed of eighteen frames, which change in a period of time of approximately one second. This sequence begins with a rectangular screen in black on which appears vertical, projected beams of light of varying intensity and colour. These lighting effects appear in a progressive manner, then fade, then once again appear in a progressive manner before disappearing completely. Simultaneously, and progressively, the name "STUDIOCANAL" appears by degrees ("SS", "STU", "STUDIO", "STUDIOCANAL") from left to right and in the background, firstly blurred and hidden, then with shifting mirror and lighting effects it emerges and finally is placed integrally at the very front, and in the centre of the screen, in white, bold capital letters, in a black frame, then finally simply on a black background.</p>				
EM	10525046	 <p>The trademark is a sequence of images which runs in any given advertisement banner. In one corner of the advertisement banner, shown merely by way of example, the sign with "i" shown in the top, first image, image 1, is displayed first. The image sequence, as shown in image 1, image 2, image 3 and image 4, starts only when the user moves the mouse pointer over the sign with "i" without clicking on it, or when he clicks on it. In the process, the sign expands outwards from the corner of the banner in a short time, specifically in less than one second, into a large sign with a message, as shown in the fourth image. The large sign is smaller</p>	35 42	Adnologies GmbH	E	2014

		than the advertisement banner. The large sign, according to image 4, containing the message remains open until the user moves the mouse pointer away from the large sign again. In this case, the image sequence starts in the reverse order, i.e. image 4 - 3 - 2 - 1, until the sign with "i" is displayed in the corner of the banner again. The large sign in image 4 shows, for example, text which informs the user that he can obtain further information about the reasons for the selection of the advertising displayed in the banner if he clicks on the large sign with the mouse pointer. The inner edges of the sign with "i" are rounded and bordered by a light-coloured line. The outer edges of the sign with "i" are cut away and coincide with the edges of the advertising banner				
EM	10763241	<p>Eine bewegte, farbige Grafik mit einer animierten Bildfolge, bei der sich ein Unendlichkeitssymbol vom Zuschauer weg bewegt und sich dabei in eine stilisierte Form des Worts "HISAMITSU" verwandelt, während sich einige vertikal angeordnete blaue Balken aus dem Unendlichkeitssymbol schnell nach links und rechts bewegen. Zeitgleich bewegt sich ein größeres Unendlichkeitssymbol im Hintergrund und wird langsam ausgeblendet</p> <p>animated sequence of images that start with an infinity symbol traveling away from the viewer, which is then quickly transformed into a stylized form of "HISAMITSU" while a series of vertical blue bars originating in the infinity symbol move quickly both to the right and to the left of the infinity symbol. During this sequence, in the background, a larger infinity symbol moves and fades away</p>	3 10 35	Hisamitsu Pharmaceutical Co., Inc	R	2012

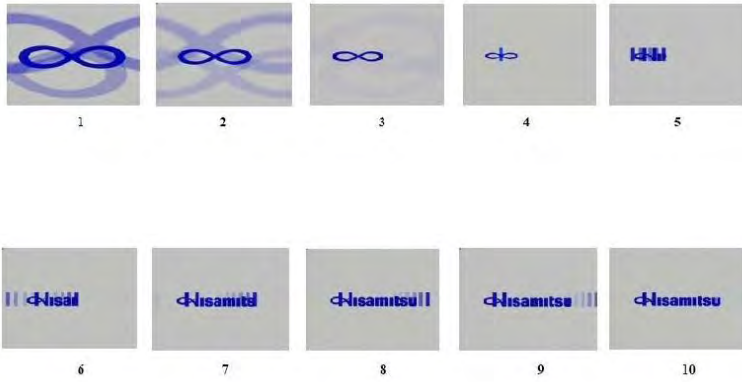
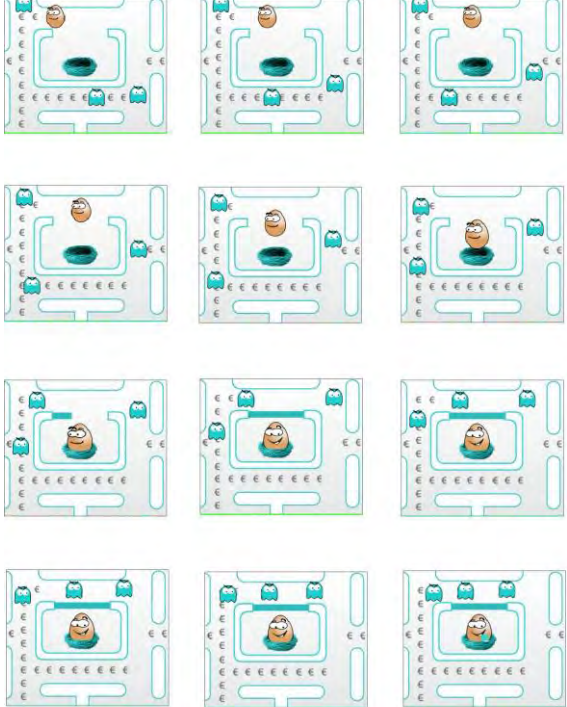
						
EM	10815967	 <p data-bbox="472 1289 1216 1375">Besteht aus einer animierten Sequenz, bei der sich ein Ei in einem Labyrinth bewegt und "€" (Euro-Symbole) einsammelt,</p>	16 36 38	Banca Carrige	R	2012

		<p>während es von stilisierten Gespenstern eingekreist und verfolgt wird, damit es nicht in sein in einem rechteckigen Gehege befindliches Nest gelangen kann. Das Ei bewegt sich mit ernstem Blick von links nach rechts und anschließend von unten bis in die Höhe der Öffnung des in der Mitte des Bildschirms befindlichen Rechtecks. Wenn das Ei sein Nest inmitten des Rechtecks erreicht und sich das rechteckige Gehege schließt, beginnt das Ei zu lächeln. Die beigefügte grafische Darstellung besteht aus zwölf (12) unbeweglichen Bildern, die verschiedene Positionen der animierten Sequenz zeigen. Die animierte Sequenz hat eine Länge von etwa zwei Sekunden</p> <p>The trademark is composed of an animated sequence representing a small egg which is moving inside a maze, collecting "€"s (the Euro symbol), surrounded and followed by stylised ghosts until he manages to reach his nest, enclosed within a rectangular perimeter. In particular, the egg moves, with a serious expression, from left to right and then downwards to the level of the opening of the rectangle positioned in the centre of the screen. When he reaches his nest in the centre of the rectangle, and the rectangular fence closes, the egg's expression changes to a smile. The representation attached depicts 12 (twelve) image stills which show different points of the animated sequence. The length of the animated sequence is around two seconds</p>				
--	--	--	--	--	--	--

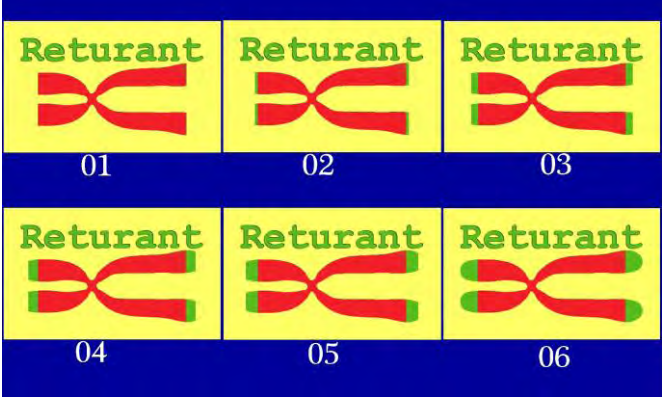
EM	10941821		An	41, 43, 44, 45	Ole larsen	R	2013
		<p>An animated, horizontal, "X"-like streamlined figure, with the central body of the 4-legged figure being in red and the end of each of the four legs being in a different colour, namely green, and gradually growing out from the body from 0 to full length, when the image opens. The background is yellow. The word "Returant" is written above the figure. Animierte "X"-lignende liegende stromlinienförmige Figur, bei der der zentrale Körper der vierbeinigen Figur rot ist, und bei der das Ende jedes der vier Beine eine andere Farbe hat, nämlich Grün, und allmählich aus dem Körper herauswächst, von 0 bis zur vollen Länge, wenn man das Bild öffnet. Die Hintergrundfarbe ist Gelb. Über der Figur steht das Wort "returant".</p>					

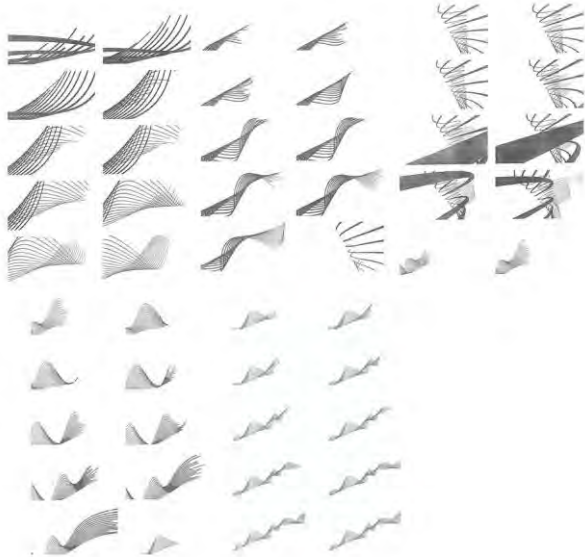
EM	11218121	 <p data-bbox="1070 715 1198 742">Movement</p> <p data-bbox="472 751 1261 1072">mark. The trademark is an animated sequence consisting of a moving/flowing spirograph composed of a series of lines. There are 50 stills in the sequence. The spirograph moves diagonally from the bottom left of the screen to the top right of the screen as the sequence progresses from the 1st still to the 50th still. The movement of the spirograph is in an intertwining motion consisting of folds and waves and the ends of each line of the spirograph are illuminated throughout the sequence. Different perspectives of the spirograph are shown throughout the sequence.</p>	9 36	IG Group Ltd	R	2013
----	----------	---	------	--------------	---	------

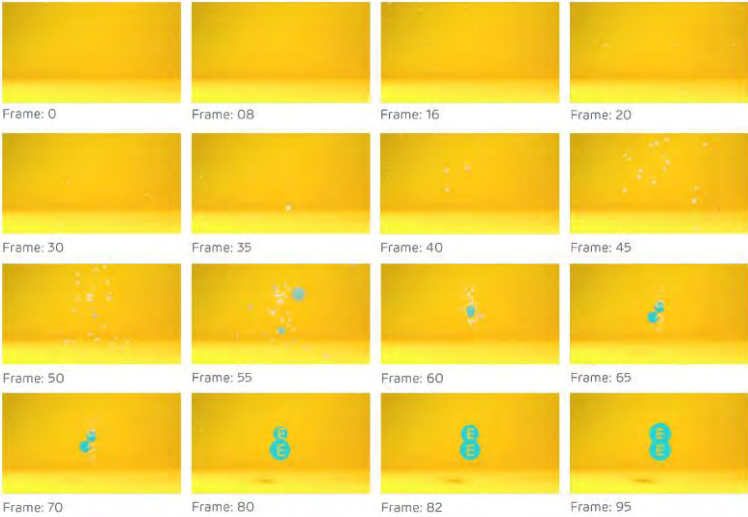
EM	11312238	<p>EE Tumble</p> 	7 9 16, 25 28, 36 37 39 42 45	Tree Tree Limited	E R	2015
EM	11312253	<p>EE Displacement</p> 	9 16, 25 28, 36 37 39 42 45	Tree Tree Limited	E W	2013

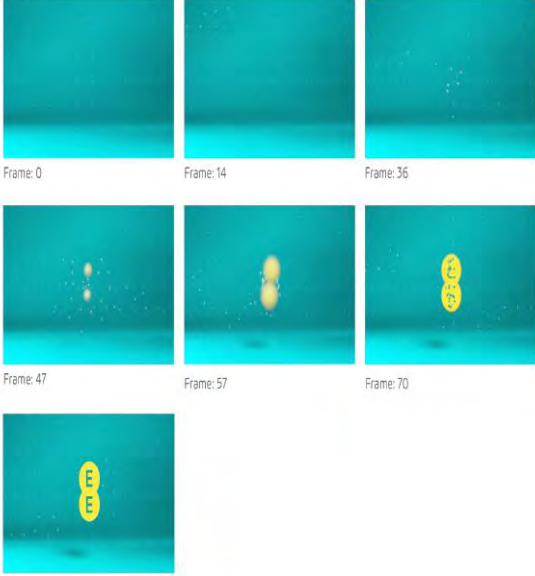
EM	11312303	<p>EE Hero</p>  <p>Frame: 0 Frame: 14 Frame: 36</p> <p>Frame: 47 Frame: 57 Frame: 70</p> <p>Frame: 99</p> <p>The mark comprises a moving image consisting of an animated visual sequence initially comprising a number of rows of 3D white particles spread across a graduated blue background. Some new, more prominent white particles appear from the top left hand corner towards the middle of the image. They are joined by more particles which have appeared from the central background of the image. Two bigger yellow particles also appear from the background and move towards the front where they are surrounded by the moving white particles. The two yellow particles then position themselves in the middle of the image one on top of the other and the white particles change colour from white to blue and form the letters "EE" inside the yellow particles. The representation consists of 7 stills, representing selected frames from the animated sequence. / Besteht aus einem bewegten Bild, nämlich aus einer animierten Sequenz, in der anfangs mehrere Reihen weißer Partikel in 3D vor</p>	7 9 16, 25 28, 36 37 39 42 45	Tree Tree Limited	E O R	2015
----	----------	--	---	-------------------	-------	------

		<p>einem untergliederten blauen Hintergrund verteilt sind, daraufhin erscheinen vom oberen linken Rand zur Mitte des Bildes hin weitere, markantere weiße Partikel, weitere Partikel erscheinen im Hintergrund in der Bildmitte, zusätzlich erscheinen zwei größere gelbe Partikel im Hintergrund und bewegen sich auf den Vordergrund zu, wo sie von den sich bewegenden weißen Partikeln umkreist werden, die zwei gelben Partikel positionieren sich hernach übereinander in der Mitte des Bildes und die weißen Partikel verändern ihre Farbe von weiß zu blau und bilden die Buchstaben "EE" innerhalb der gelben Partikel, die Darstellung besteht aus 7 Stillbildern mit ausgewählten Bildern aus der animierten Sequenz</p>				
EM	11766839	 <p>The mark consists of a motion mark consisting of the stylised wording "salonpas" in white stylised lettering carried on a blue banner featuring a light blue starburst; the blue banner having a gray top edge and a green bottom edge. The motion mark further consists of an animated sequence of images in which the blue banner with</p>	5	Hisamitsu pharmaceutical Co Inc.	R	2013

		<p>green lower edge appear close up. As the perspective moves away from the banner, the letters of the word "salonpas" appear sequentially from left to right and become smaller in size until they completely spell out the word "salonpas". After "salonpas" is spelled out, the starburst behind the word "salonpas" briefly becomes brighter / Besteht aus einer Bewegungsmarke mit dem stilisierten Schriftzug "salonpas" in weißen stilisierten Buchstaben auf einem blauen Banner mit hellblauem Strahlenkranz, das blaue Banner hat einen grauen oberen Rand und einen grünen unteren Rand, ferner besteht die Bewegungsmarke aus einer animierten Bildsequenz, bei der das blaue Banner mit dem grünen unteren Rand von Nahem erscheint, während es dann allmählich ferner rückt, erscheinen die Buchstaben des Wortes "salonpas" nacheinander von links nach rechts und werden dabei kleiner, bis das Wort "salonpas" vollständig ausbuchstabiert ist, nachdem "salonpas" ausbuchstabiert ist, wird der Strahlenkranz hinter dem Wort "salonpas" kurz heller.</p>				
--	--	---	--	--	--	--

EM	12006995	 <p data-bbox="481 869 1272 1380">The mark consists of a motion mark formed by the word "UTROS" in stylized letters with shadow, the word elements "United Tribes Organization" in italic letters, justified aligned under the previous word and two sets of circles with variable diameter, presented as two arches one on top of the other, featuring inside a stylized image of two birds, this all on a pale background, wherein in one of the series of circles a filled circle moves from left to right, while for the other series of circles that movement goes in the opposite direction / Besteht aus einer Bewegungsmarke mit dem Schriftzug "UTROS" aus schattierten, stilisierten Buchstaben, den Wortelementen "United Tribes Organization" in Kursivschrift, bündig unter dem vorhergehenden Wort ausgerichtet und zwei Reihen von Kreisen mit unterschiedlichem Durchmesser, die übereinander in Form von</p>	38 41	United tribes Organisation, NL	R	2013
----	----------	---	-------	--------------------------------	---	------

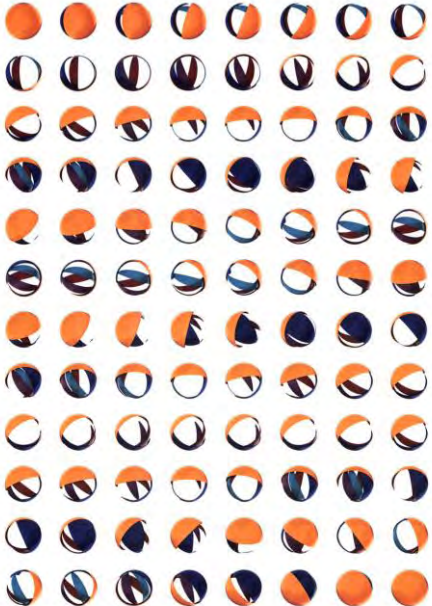

		zwei Bögen dargestellt sind, in deren Innerem befindet sich die stilisierte Darstellung von zwei Vögeln, alles auf einem hellen Hintergrund, wobei sich in einer Reihe von Kreisen ein gefüllter Kreis von links nach rechts bewegt, während diese Bewegung in der anderen Reihe von Kreisen in entgegengesetzter Richtung verläuft.				
EM	12210571	 <p>The trademark is an animated sequence that begins with a representation of a bright green rectangle in its full length. The bright rectangle that occupies about a quarter of the height of the image flattens more and more and then gradually and horizontally converges with toward the middle of the image. The number with 10 digits involving decimal point gradually rises from the inside of the band of shine/light and the number changes randomly and many times. The pattern designs in the form of diagonal lines spreads toward right and left from both sides of the number. The number is fixed with 0.00000001, blurs gradually and goes to blend into the flash/light. These figures are replaced by the words "NANOALLOY" (written in white) and "TECHNOLOGY" (located</p>	1 12 17 22 23 24 25 28	Toray K. K.	R	2014

		<p>below and written in green in a smaller font size). Silver shades then appear at the bottom of the letters of the word "NANOALLOY". The total length of the animated sequence is approximately 4 sec. / Besteht aus einer animierten Sequenz, die mit der Darstellung eines hellgrünen Rechtecks in voller Länge beginnt, das etwa ein Viertel der Bildhöhe einnehmende helle Rechteck wird danach immer dünner und zieht sich schließlich schrittweise und horizontal in Richtung der Bildmitte zusammen, aus dem Innern des leuchtenden Bandes erscheint schrittweise eine Zahl mit zehn Ziffern und einem Dezimalpunkt, wobei sich die Zahl zufällig und viele Male verändert, beiderseits der Zahl breiten sich Grafikelemente in Form diagonaler Linien nach rechts und links aus, schließlich bleibt die Zahl als 0.000000001 stehen, schwimmt schrittweise und geht in einem Blitz/Licht auf, diese Grafik wird durch die Wörter "NANOALLOY" (in weißer Schrift) und "TECHNOLOGY" (darunter angeordnet sowie grün und in kleinerer Schrift geschrieben) ersetzt, woraufhin silberne Schattierungen an der Unterseite der Buchstaben des Wortes "NANOALLOY" erscheinen - die animierte Sequenz dauert insgesamt etwa vier Sekunden.</p>				
--	--	--	--	--	--	--

EM	12274296	 <p data-bbox="472 794 1252 1074">The trade mark is an animated sequence consisting of a rotating spherical device, which is produced by sequentially displaying the attached images in the order given, starting from the top left corner moving across the row to the far right, returning to the second left row and moving across again to the far right, continuing in this order from left to right, ending with the image on the far right of the last row, whereupon the sequence will recommence</p>	9 35 36 38 42	Visa Europe Ltd	R	2014
----	----------	--	------------------	-----------------	---	------

EM	12642567	 <p>The trade mark is an animation as shown in the representations attached to the application. It is composed of "50" sequences ("1" to "50") that lasts "10" seconds in total. The starting point is an orange triangle that multiplies to show an increasing number of orange and grey triangles and triangular arrow devices which start to overlap (frames "1" through to "15"); the triangles/arrow devices then appear to gradually turn into a group of runners viewed from the side (frames "16" to "18"), then from both the front and from the side (frames "19" to "37"), then the runners appear to gradually become orange and grey triangles and triangular arrow devices (frames "38" to "47") and the number of triangles/arrow devices gradually decreases until finally there is a single orange triangle (frame "48"). A "FWD" logo then appears, leaving the final orange triangle from frame "48" in the center of the letter "D" in the "FWD" logo (frame "49"). In the final sequence (frame "50"), on the right side of the "FWD" logo, three runners appear viewed from the front, the central runner is orange and two side runners are in grey.</p>	9 16 35 36 38 42	Valdimir Pte. Ltd	R	2015
----	----------	--	---------------------	-------------------	---	------

EM	013225107	 <p data-bbox="472 536 1249 817">All of the representations are on a white surface. At the outset only the text "Hotel?" is readable on the white background. This text is in blue, yellow and red. The characters are divided into pairs of characters, with each pair being in a single colour. The entirety of the text is tilting forwards towards the viewer. As a result of the rotation, the previous text "Hotel?" turns into "trivago". This text has the same colours (blue, yellow and red) as the previous text.</p>	35 38 39 42 43	TRIVAGO GmbH	R	2015
----	-----------	---	-------------------	--------------	---	------

EM	13475512		9 38 42 45	Crunchfish AB	E W	2015
EM	013620059	 <p>The trademark is</p> <p>composed of the word "WEFFEX", written in upper-case letters, and a separate circle placed in front of the word, in which circle, in the lower quarter thereof, and slightly projecting beyond it, is the illustration of an iconographically drawn heart in white with a black outline, which moves between six pulses and in doing so changes to form an image of a stylised molar with two roots, and through continuous repetition changes back into the image of a heart.</p>	9 41 42 44	F X Wack	R	2015

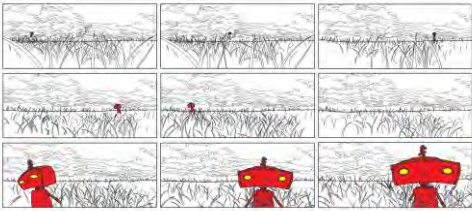
EM	013704771	 <p data-bbox="1032 156 1272 400">This is a motion</p> <p data-bbox="472 408 1272 1204">mark in colour. The nature of the motion is that of a red robot with yellow eyes running back and forth in a zigzag movement across a landscape, starting in the background and ending in the foreground. The duration of the motion is approximately 7 seconds. The stills in the sequence are spaced approximately 1 second apart. The stills are spaced consecutively from the beginning to end of sequence. The stills follow a progression from the top left (1st still) to the bottom right (9th still), moving from left to right across each row and then down to the next row. The precise sequence of the stills is as follows: In the 1st, 2nd and 3rd stills, the robot is shown running across a landscape in a left-to-right direction. In the 4th and 5th stills, the robot is shown running across the landscape in a right-to-left direction and closer to the foreground. The 6th still shows the landscape with the robot having exited the frame on the left. In that still, as in the others in the sequence, the landscape is grassy and clouds are visible in the background sky. The 7th still shows the robot entering the frame from the left and turning towards the viewer. The 8th still shows the robot moving into an upright, forward-facing position. The head, torso and arms of the robot are visible. In the 9th still, the robot faces toward the viewer, with the head, torso and arms of the robot visible, closer to the viewer, and ends the animation</p>	9 41 42	Bad Robot IP	R	2015
----	-----------	--	---------	--------------	---	------

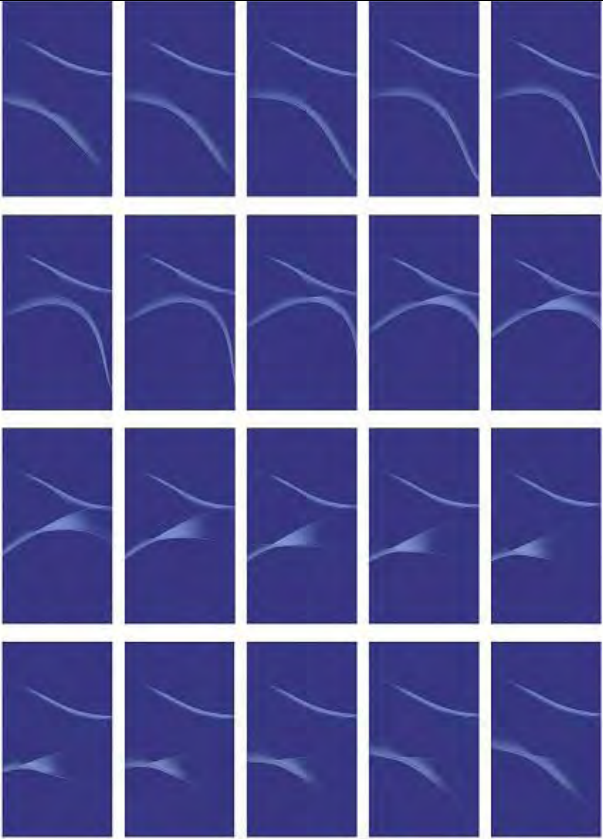
EM	013738455		This is	9 14 28	Sony Mobile Communications	R	2015
		<p>a motion mark in colour. The nature of the motion is that of two white contrail-like images, one above the other, which start out in separate areas of a blue/purple background; then they flow toward each other with the lower image becoming more ribbon-like, and then separate again with both images returning to a contrail-like appearance. The duration of the motion is approximately 3 seconds. The stills in the sequence are equally spaced approximately .15 seconds apart. The stills are spaced</p>					

		<p>consecutively from the beginning to the end of the sequence. The stills follow a progression from the top left (1st still) to the bottom right (20th still), moving from left to right across each row and then down to the next row. The specific dimensions of the background will vary depending on the specific device that is used with the mark. The precise sequence of the stills is as follows: In the 1st still, the two white contrails are separate and start near the middle of the frame, with one above the other. The upper contrail is shorter and straighter and touches the right side of the frame, while the lower contrail is longer and slighted bowed in the middle towards the upper contrail and touches the left side of the frame. In the 1st through 5th stills, the lower contrail gradually flows toward the upper contrail by bending increasingly in the middle to create a pronounced bow. In the 6th through 10th stills, the lower contrail continues to flow towards the upper contrail and becomes more arc-like, as both contrails increase in width and the lower right-hand portion of the lower contrail floats out of view. In the 11th through 15th stills, the contrails slowly move apart again as the shape of the lower contrail becomes more ribbon-like, with the thinnest portion of the ribbon on the left side of the frame and the thickest portion of the ribbon in the middle of the frame, and where the white colour gradually fades from brightest on the left side of the frame to lightest on the right side of the frame. In the 16th through 20th stills, the lower image decreases in width, moves further away from the upper contrail, and again becomes more contrail-like, ending the animation.</p>				
--	--	---	--	--	--	--

EM	013738653		This is	9 14 28	Sony Mobile Communications	9	2015
		<p>a motion mark in colour. The nature of the motion is that of an electric wave consisting of flowing elements of the colours yellow, orange, pink, red, blue, and green, which flow into the left side of a black background at different wavelengths; they peak in size and intensity in a confluence in the middle of the frame, and then flow out of the right side of the black background, with the colour fading out. The duration of the motion is approximately 3.75 seconds. The stills in the sequence are equally spaced approximately .2 seconds</p>					

		<p>apart. The stills are spaced consecutively from the beginning to the end of the sequence. The stills follow a progression from the top left (1st still) to the bottom right (20th still), moving from left to right across each row and then down to the next row. The specific dimensions of the background will vary depending on the specific device that is used with the mark. The precise sequence of the stills is as follows: In the 1st and 2nd stills, only a black background is shown. In the 3rd still, a small portion of a pink flowing element enters the frame from the left side of the frame, in the middle of the frame. In the 4th and 5th stills, more of the wave becomes visible, as yellow, orange, red, and blue flowing elements enter the frame from the left side of the frame, and all coloured flowing elements stretch toward the center of the frame. In the 6th through 9th stills, the colours in the electric wave become brighter and the flowing elements become thicker, as the wavelengths peak in size and activity and fill the middle of the frame, moving toward the right side of the frame. The pink flowing element appears in the bottom portion of the wave, the yellow and orange flowing elements appear in the middle of the electric wave and the red, blue and green flowing elements appear toward the upper portion of the wave. In the 10th through 12th stills, the coloured flowing elements start to exit the right side of the frame, in the middle of the frame, as the wave decreases in in size and brightness. In the 13th through 17th stills, the electric wave continues to fade in brightness and shrink in size until it is barely visible as a small, more linear cluster of colours situated in the middle of the right side of the frame, with orange and yellow most visible, as the wave exits. In the 18th through 20th stills, only a black background is visible, ending the animation.</p>				
--	--	--	--	--	--	--

EM	013805536	 <p>This is a motion mark in colour. The nature of the motion is that of an animated, undulating set of waves in shades of blue/purple. The wave set is shown from a cross-section perspective. An illuminated blue/purple background is shown above the wave set, and an unilluminated blue/purple foreground is shown below it. The duration of the motion is approximately 3 seconds. The stills in the sequence are equally spaced approximately 15 seconds apart. The stills are spaced consecutively from the beginning to the end of the sequence. The stills follow a progression from left (1st still) to right (5th still). The specific dimensions of the background will vary depending on the specific device that is used with the mark. In all stills, the middle of frame features a wave in shades of blue/purple; the top part of the frame is a blue/purple background that is illuminated, with the illumination appearing to come from behind the top of the wave; and the lower part of the frame is a blue/purple foreground that is unilluminated. Parts of each wave rise and fall at different rates, in shades of blue/purple, as the waves move from left to right. The precise sequence of the stills is as follows: In the 1st still, the overall wave appears at a crest. In the 2nd still, it appears at a trough. In the 3rd still, it appears at a crest. In the 4th still, it appears at a trough. In 5th still, it appears at a crest, ending the animation.</p>	9	Sony Mobile Communications	R	2015
----	-----------	--	---	----------------------------	---	------

EM	014103634	 <p data-bbox="472 711 1227 962">motion mark in color. It consists in 8 pictures sequencing the following movement: The "Tide" brand logo appears from the left hand side with more and more speed, leaving behind it a white swoosh, until it stops when it reaches the right hand side of the screen. Because of the movement and speed, the logo is blurred until it stops, at which point it appears well-defined. The whole movement lasts 2.5 seconds</p>	This is a	3 5	The Procter & Gamble	R	2015
----	-----------	---	-----------	-----	----------------------	---	------

EM	014293583		The trademark consists of	9 10 44	DIVALOR SALUD	R	2015
		<p>an animated sequence in the centre of which is the name "davalor" behind which are two rotating circles (one in blue and the other in purple). The sequence is a few seconds long and repeats indefinitely.</p>					

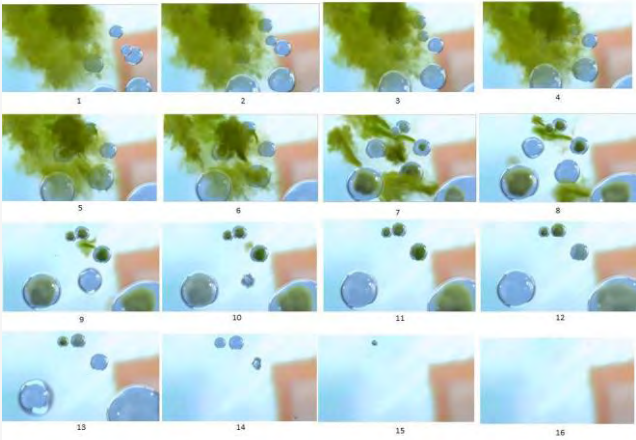
EM	014482327	 <p>This is a</p> <p>motion mark in colour. The trade mark consists of an animated sequence representing a green cloud/smoky substance being absorbed by transparent bubbles which are then filled by this substance prior to imploding and disappearing completely. The duration of the movement is approximately 2 seconds. The 16 stills in the sequence are spaced approximately 0.125 seconds apart. The 1st still is the upper left still. The last still (16th) is on the bottom right. The precise sequence of the stills is as follows: from the 1st still to the 9th still, the bubbles featured absorb the green cloudy/smoky substance and are filled by it; starting in still 10 until still 15, these bubbles begin to implode one at a time; in still 16 they have all disappeared, leaving only the background image.</p>	3 5	The Procter & Gamble	E W	2015
EM	014526263	<p>[+] [+] + [-] [-] The mark is a movement or revolving motion mark. The trade mark is an animated sequence consisting of the plus and minus mathematical symbols, contained, at some stages, within a pair of square brackets, such that starting from the position of "[+]", the mark progresses through five stages to "[-]". The estimated time for the motion mark cycle is approximately 6/10 of a second per switch between the "[+]" and "[-]"</p>	35 42	Union Lab	E	2016

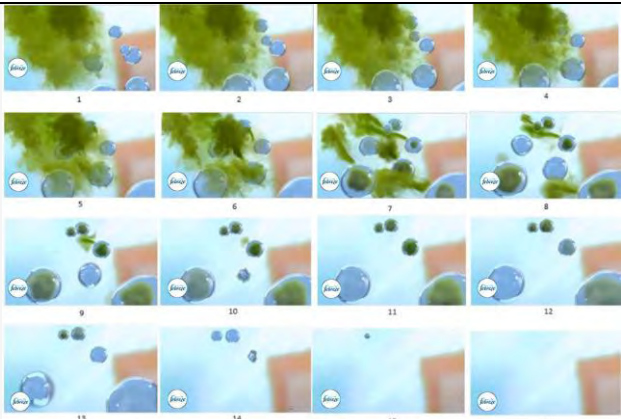

]", or four (4) seconds total to transition back to start.				
EM	014607691	 <p>Febreze This</p> <p>is a motion mark in colour. The trade mark consists of an animated sequence representing a green cloud/smoky substance being absorbed by transparent bubbles which are then filled by this substance prior to imploding and disappearing completely. The duration of the movement is approximately 2 seconds. The 16 stills in the sequence are spaced approximately 0.125 seconds apart. The 1st still is the upper left still. The last still (16th) is on the bottom right. The precise sequence of the stills is as follows: from the 1st still to the 9th still, the bubbles featured absorb the green cloudy/smoky substance and are filled by it; starting in still 10 until still 15, these bubbles begin to implode one at a time; in still 16 they have all disappeared, leaving only the background image</p>	3 5	The Procter & Gamble	R	2016

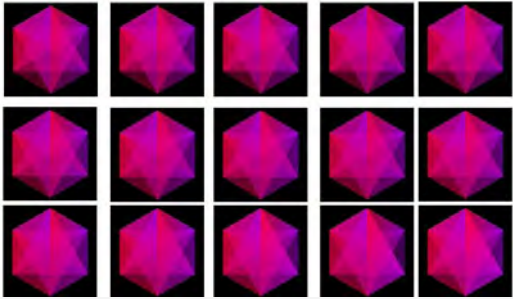

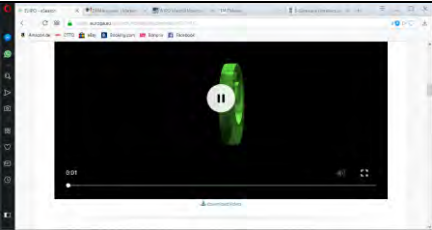
EM	014772909		<p>The label consists of a moving picture,</p> <p>which the circular periphery of the set of round discs in such a way that they are lying position, and wherein each wafer in turn sequentially turns up in one image and returns to its side in the next image so that the wafer motion advancing wave (CW) along the wafer a and that the reel on its side, it returned the next turns up</p>	9 36	Mepay Oy	E	2016
----	-----------	---	--	------	----------	---	------

EM	014876338	 <p>The movements in</p> <p>the mark shows various shapes inside the hexagon in various purple shades in the form of triangles, squares, diamond-shaped and star-shaped. Each movement is done with a fixed interval. The colors in the figures exchanger with varying light intensity, and the total length of the animated sequence is about 12 x the chosen fixed time interval (frequency) seconds when the mark is made up of 12 elements. The fixed time interval (frequency) can be varied and controls the illusion of movement (shimmering), typically the frequency is between 0.5 and 2 seconds. Mark basic elements formed by 12 triangles of different sizes in a colored semi-transparent gradient of colors in a spectrum defined by the colors "HEX ff0046 # / # b400ff" in the angle: 0 °. The brand's animated sequence is shown in the graphic representation of 3 rows of still images to be viewed from left to right in the first row, from right to left in the 2nd row and from left to right in the third row</p>	5 42 44	Nuevolution A/S	E	2016
----	-----------	---	---------	-----------------	---	------

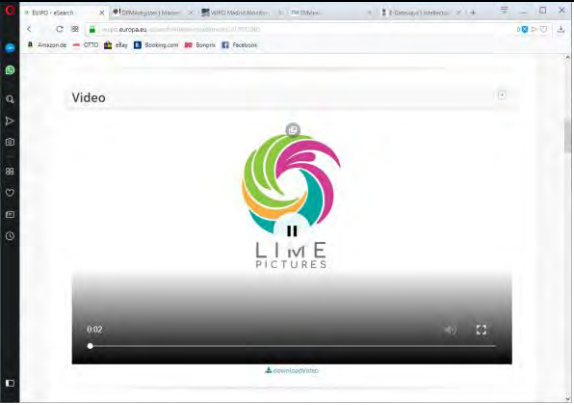
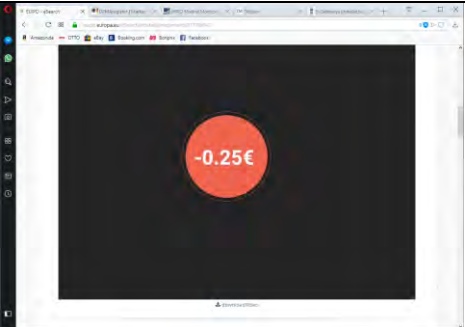

EM	014958508	 <p data-bbox="472 919 1236 1054">Angemeldet wird eine sonstige Marke in der spezifischen Form einer Bewegungs-marke. Die Bewegung verläuft in der Abfolge der Bilder Layer 1 bis 6. Dabei wechselt nur die Farbtönung</p>	35 36 38 42	Sonnenberg, Hein	E	2016
EM	017279712	<p data-bbox="472 1342 555 1369">Video</p> 	35 42 45	Ports Group	R	2018

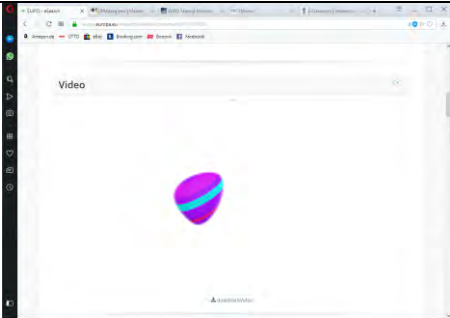
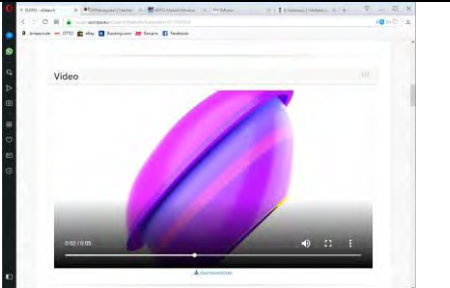
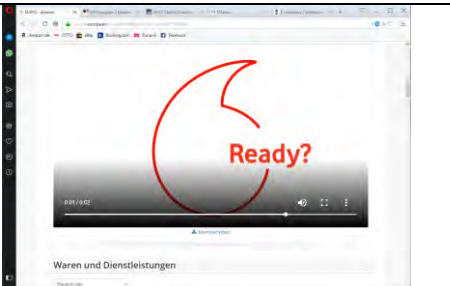
EM	017286295	Video 	35 42 45	Ports Group	R	2018
EM	017492513	Video 	1 4 37	Castol	R	2018
EM	086521175	Video 	9 35 36 37	Telia	R	2018
EM	017794281	Video 	9 12	Nio Nextev	E W	2018

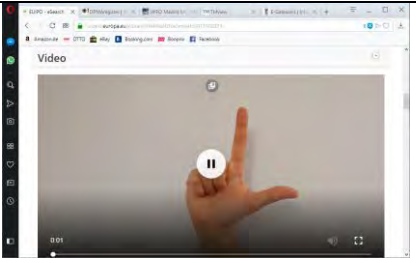
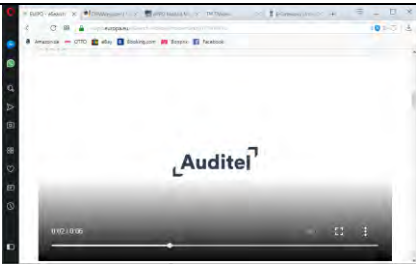
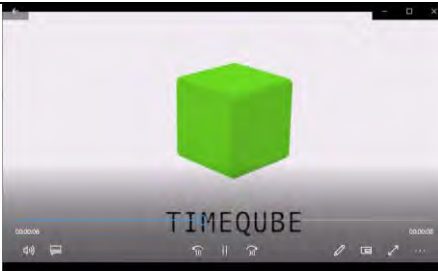

EM	017835679	<p>Video</p> 	32 33	Electromeccanica	R	2018
EM	017852187		30	Boermarke	E	2019
EM	017872895	<p>Video</p> 	9 16 38 41 42	Lime Pictures	R	2018
EM	017888942	<p>Video</p> 	9 36 38 41 42	Wintrado	E	2019

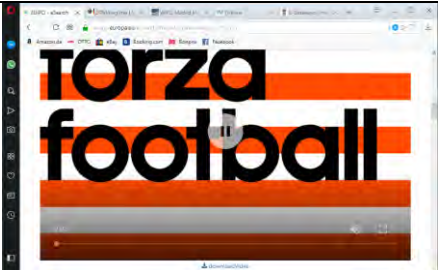
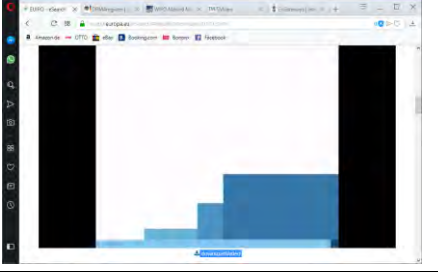

EM	017891063	Video 	9 35 36 37 38 41	Telia	E O	2019
EM	017891056	Video 	9 35 36 37 38 41	Telia	E O	2019
EM	017894840	Video 	9 35 38 41	Vodafone group	R	2018
EM	017894400	Video 	9 16 35 41	Göteborgpriset	R	2018

EM	017902920	Video		9 35 42 45	Everseen	R	2018
EM	017902876	Video		35 36 44 45	Fundacio	R	2018
EM	017906814	Video		9 35 38 41 42	AUDITEL	EO	2019
EM	017911214	Video		14	A. Dobrucki	R	2018

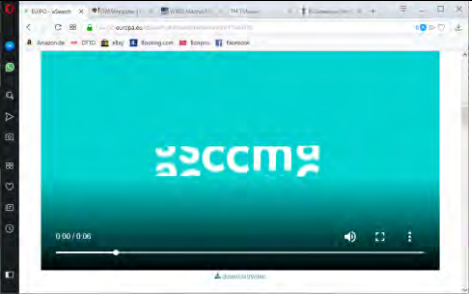

EM	017912571	<p>Video</p> 	9 35 38 41 42	Footballaddicts	R	2018
EM	017921619	<p>Video</p> 	36	Citygroup	E	2019
EM	017921622	 <p>The mark consists of a motion. First, there is a light blue rectangle on the bottom. Then, a small dark blue square rises from the bottom on the far right of the light blue rectangle, and together they form a row. Then, three blue rectangles of varying heights and shading move and expand from right to left, so that they are positioned in ascending order above the row comprised of the lighter blue rectangle and dark blue square.</p>	36	Citigroup	E	2019
EM	017934434	<p>Video</p> 	5 9 41 42 44	SANOFI	E R	2018

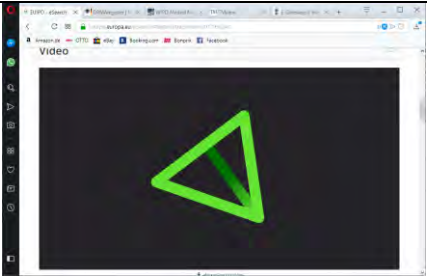
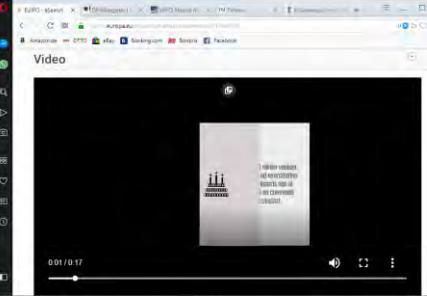
EM	017934795	Video		9 42	Everseen	R	2018
EM	017938047	Video		5 9 41 42 44	Sanofi	E R	2019
EM	017938779	Video		9 35 36 41 44	Assicurazioni Generali	R	2018

EM	17946310	<p>Video</p> 	9 25 28 35 38	Casumo Services	R	2018
EM	17952705	<p>Video</p> 	4 7 9 11 12 35 36	ENEL	E R	2019
EM	17954790	<p>Video</p> 	35	Dynasource	E R	2019

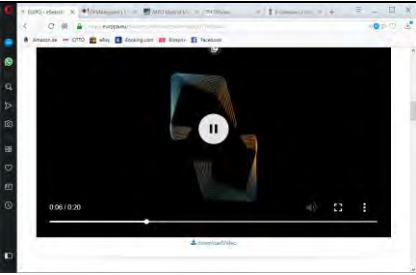
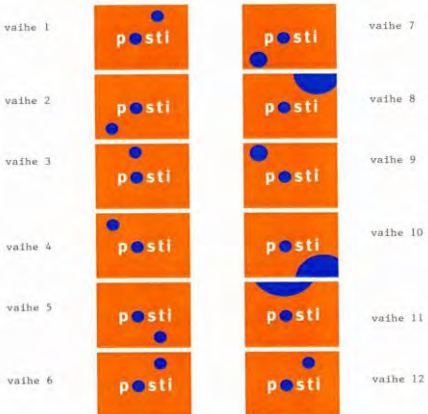
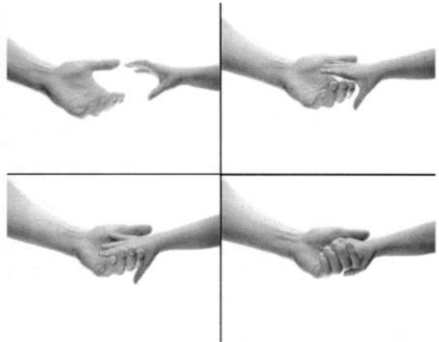
EM	17958240	Video 	9 36	Trustly Group	E R	2019
EM	17967247	Video 	16	Diarmad McNally	E R	2019
EM	17970781	Video 	9	Crunchfish	E	2019
EM	17973058	Video 	42	Illumina	E	2019



EM	017992443	 <p>Video</p>	35 42	Bang Media Group	E	2019
FI	229446		35 38 39	Suomen Posti Oyj	R	2000
FI	T2003 02453	 <p>Die Marke ist eine Animation, die aus vier Bildern besteht, auf denen sich Hände nacheinander von links nach rechts und von oben nach unten begegnen</p>	9 25 28 38 41	Nokia Corp.	2003	R

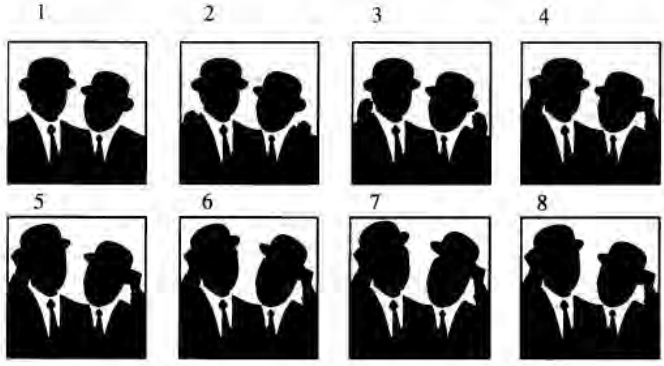

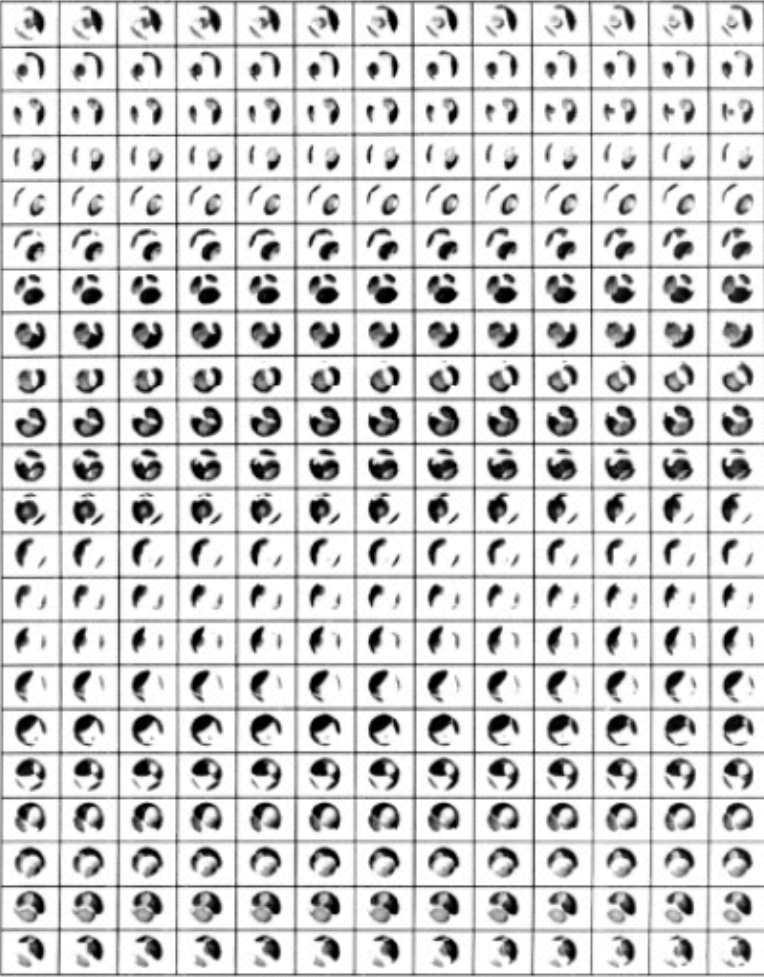
FR	073493511	 <p>Description de la marque : LA TOUTOUYOUTA est une danse qui se décompose en 5 mouvements qui sont représentés par des pictogrammes et qui sont décrits par les termes suivants : " serviette ", " le téléphone qui capte pas ", " le changement de slip ", " l'oursin ", " la crème solaire " .</p> <p>Der Toutouyouta ist ein Tanz, der sich aus 5 Figuren zusammensetzt, wie die Piktogramme zeigen und durch die folgenden Begriffe beschrieben wird: Rückenabtrocknen, keine Verbindung am Handy, Slipwechsel, Stachel in Fuss, Eincremen</p>	3 9 28 41	118 218 S.a.r.l	R	2007
GB	2012603	 <p>The mark is a gesture made by a person by tapping one side of his / her nose with an extended finger on the side of the nose being</p>	36	Derbyshire Building Society	R	1995

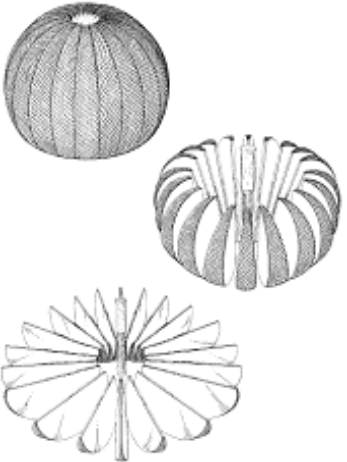
		tapped. An example is shown above. (by extended use) Die Marke betrifft eine Geste einer Person, die mit ausgestreckten Finger ihre Nase berührt. Ein Beispiel ist vorstehend wiedergegeben (über Verkehrsdurchsetzung)				
GB	2130164	 <p>The trade mark consists of a representation of the two characters illustrated in the first frame of the sequence of illustrations attached slowly raising their hats as illustrated in frames two through eight of the said sequence and then replacing their hats as illustrated in frames eight through two of the sequence and at the conclusion of the sequence returning to the representation as shown in the first frame.</p> <p>Die Marke besteht aus der Wiedergabe von 2 Personen, die im ersten Bild der Sequenz wiedergegeben sind, die in den Bildern 2 bis 8 langsam Ihren Hut heben und dann wieder aufsetzen, wobei nach der Wiedergabe von Bild 8 die Bildfolge wieder von vorne beginnt.</p>	36	Bradford & Bingley	R	1998

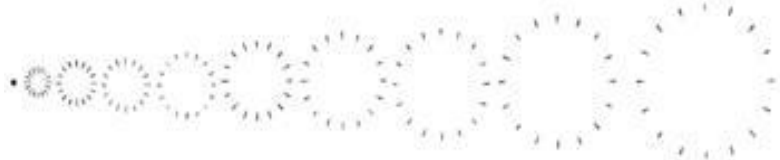

GB	2235348	 <p data-bbox="472 1157 1256 1366">The trade mark is an animated sequence consisting of a rotating globe device, in which the continents are depicted in the colours red, pink, purple, blue, green, yellow and orange, which is produced by sequentially displaying the attached images in the order given, starting from the top left corner moving across the row to the far right, returns to the second left row and moves across again to the</p>	9 38	British telecom Ltd	R	2003
----	---------	--	------	---------------------	---	------

		far right, continuing in this order from left to right, ending with the bottom right corner, whereupon the sequence will recommence.					
GB	2250465	 <p>The moving image design mark consists of an animated visual sequence depicting a square dot with rounded corners on the letters Y, E, L, and L. After the initial display of the empty square dot with rounded corners for a few seconds, the letters Y, E, L and L appear in quick succession inside the square dot, so as to spell the word YELL. The letters are separated by a brief display of the empty square dot. The drawing consists of eight stills that make up the sequence.</p>	9 16 35 36 37 38 39 41 42	Yell Ltd	R	2003	
GB	2280003			30	Kraft Foods U.K. Ltd	R	2002
IT	722306	<p>Marche consistant dans la représentation d'une main, les trois doigts centraux repliés et le pouce et l'auriculaire étendus vers le haut figurant un mouvement à traits minces sur fond vide; dans le poignet l'élément verbal LA MAGGIOLINA en caractères moulés majuscules à l'exception de l'article LA en caractères moulés majuscules, à l'exception de l'article LA en caractères italiques à trait mince sur fond vide.</p>	14 16 25	Al.Mi	R	1997	

NZ	621400	 <p>The mark comprises an animated sequence made up of eight stills that flash one after the other, in the order shown in the representation attached to the application form. Each still includes a solitary square shape with rounded corners. The first, third, fifth and seventh stills consist solely of the square shape with rounded corners. The second still consists of the square, with the capital letter "Y", contained within. The fourth still consists of the square, with the capital letter "E" contained within. The sixth still consists of the square, with the capital letter "L" contained within. The eighth still consists of the square, with the capital letter "L" contained within. The flash of each still in the sequence is less than one second in duration.</p>	9 38 42	British Telecom	W	2000
NZ	646935	 <p>The mark comprises of an animated progression of the colour red turning into the colour green in an upward sweep as illustrated by three glimpses of the animated progression of the sweep from one colour to the next. The first glimpse represents a beginning of the animated progression of the sweep of colours, while the second glimpse represents a mid-point of the animated progression of the sweep of colours, and the third glimpse represents an end of the animated progression of the sweep of colours as all contained in the representation attached to the application.</p>	5	Bayer Consumer Care AG	R	2002

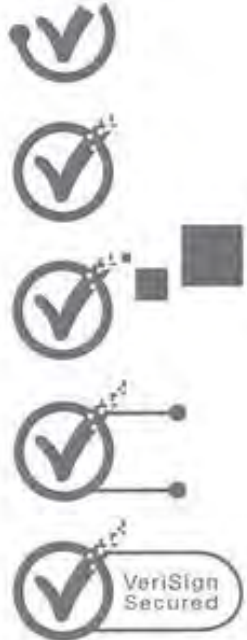
NZ	702324	 <p>The mark comprises of an animated progression of a continuous explosion as illustrated by ten glimpses as shown in the attached representation. The first glimpse represents the beginning of the animated progression at the commencement of the explosion. The second to ninth glimpses show eight intervening glimpses of the progression of the explosion. The tenth glimpse represents the last part of the explosion.</p>	35	The Farmers Trading Company Ltd	E W	2004
NZ	706210	<p>(1) The mark consists of a moving image of a stream of data made up of separate streams of alphanumeric symbols and light moving substantially in the same direction. 2) The mark consists of an image of a stream of data made up of separate streams of alphanumeric symbols and light apparently moving substantially in the same direction</p>	9 38 42	Woosh Wireless Ltd	E W	2005
NZ	722165		39	Luxury Airport Shuttle Service Ltd	E W	2005

NZ	727012	 <p data-bbox="472 815 1256 1362">The mark consists of an animated progression of a check mark as shown in the representation attached to the application and as recorded on the CD-ROM accompanying the application. The first still shows the beginning of the check mark element being drawn, as well as the beginning of the circle element being drawn. The second still shows the check mark element continuing to be drawn and the completion of the circle element. The third still shows the complete circle design, the check mark element continuing to be drawn through the addition of square elements moving into place to form the pixelized end of the check mark. The fourth still shows the complete circle element, the complete check mark element, and the start of the capsule element being drawn as it extends from the right-hand side of the circle element at the top and bottom. The final still shows the complete mark consisting of the circle element, check mark element</p>	9 35 36 41 42	VeriSign Inc.	E R	2007
----	--------	--	------------------	---------------	-----	------

		(including the pixelized end of the checkmark), capsule element extending off of the right-hand side of the circle element framing the wording "VERISIGN SECURED" .				
NZ	738829	 <p>The mark comprises an animated progression of concentric circles of white and the colour blue expanding and contracting as shown in the representation attached to the application. The first glimpse represents a beginning of the animated progression of concentric circles of white and the colour blue expanding and contracting. The second and fourth glimpses represent a progression in the expansion and contraction of the white and blue circles. The third glimpse represents a mid-point in the animated progression of concentric circles of white and blue expanding and contracting, and the fifth glimpse represents an end of the animated progression of concentric circles of white and blue colour expanding and contracting</p>	9 10	B2P Ltd	E R	2006
NZ	747835	 <p>The mark comprises an animated progression of a fern frond increasing in size and a shaft of light expanding outwards from the centre of the frond and concluding in an image of curved lines within two concentric circles and the text CREATION PICTURES, as shown in the representation attached to the application, and as recorded on the CD accompanying the application. The first still consists of a fern frond, the second still represents the beginning of the animated progression of light expanding outwards from the centre of the frond, the third to twelfth stills represent the progression of the light expanding outwards from the frond, and the thirteenth still represents the end of the light expanding from the centre of the frond. The fourteenth still consists of curved lines within two concentric circles above the words CREATION PICTURES</p>	41	Creation Pictures Ltd	E R	2006

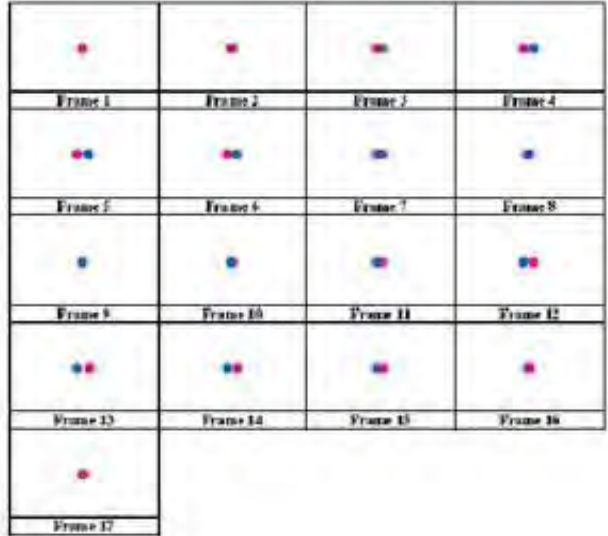
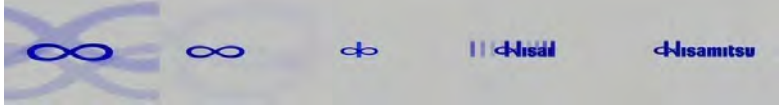
<p>NZ</p>	<p>775926</p>	 <p>The mark comprises a moving image consisting of an animated visual sequence initially comprising a pink circle (pms 226), where a blue circle (pms 3005) appears from behind the pink circle and moves to the right until it is separate from the pink circle. It then begins to move back across the pink circle to obscure it, it then proceeds to move to the left of the pink circle until it does not obscure any part of the pink circle, it then moves horizontally back behind the pink circle until it is obscured. The drawing consists of seventeen stills (or frames) that make up the animated sequence. Movement occurs at a speed of .0588 second/frame, the entire sequence completing from start to finish within 1 second's time.</p>	<p>9 35 38 40 41 42</p>	<p>Yahoo!</p>	<p>R</p>	<p>2009</p>
<p>NZ</p>	<p>781035</p>	 <p>The trade mark consists of an animated sequence of images over a</p>	<p>5</p>	<p>Hisamitsu Pharmaceutical Co Inc</p>	<p>E R</p>	<p>2009</p>

		<p>duration of one second as shown in the attachment to the application and as depicted in the WAV image available for public inspection at the Office. The animated sequence starts with an infinity symbol travelling away from the viewer, which is then quickly transformed into a stylised form of the word HISAMITSU while a series of vertical blue bars originating in the infinity symbol move quickly both to the right and to the left of the infinity symbol. During this sequence, in the background, a larger infinity symbol moves and fades away</p>				
<p>NZ</p>	<p>792452</p>	 <p>The trade mark consists of an animated sequence of images as shown in the representation attached to the application and as depicted in the WAV image available for public inspection at the Office. The animated sequence starts with an image of a cartoon duck having brown feathers and an orange beak, riding a jet ski along a roof gutter waterway. The jet ski and the duck become air borne and then land with a splash. The jet ski and the duck then launch into the air and leap between one roof gutter and the neighbouring roof</p>	<p>6 11 17 19</p>	<p>Marley New Zealand Ltd</p>	<p>R</p>	<p>2010</p>

		gutter, and land with a splash. The duck and jet ski continue along the roof gutter. The duck and jet ski approach a corner, the duck launches from the jet ski and navigates the corner swinging by hand, once the corner is navigated, the duck lands on the jet ski and they both carry on				
NZ	802554	 <p>The mark comprises of an animated progression of a bird building a nest on a branch and laying eggs therein as shown by twenty-three still shots, as shown in the representation attached to the application. Each still is placed on consecutive pages and the animation is created by manually thumbing through the pages with speed, creating the effect that the individual stills merge to one animated whole. The first still depicts the bird approaching the edge of the branch with a twig in its beak. The second to sixth stills depict the progression of the bird towards</p>	9 16 36	Shamrock Superannuation Limited	R	2009

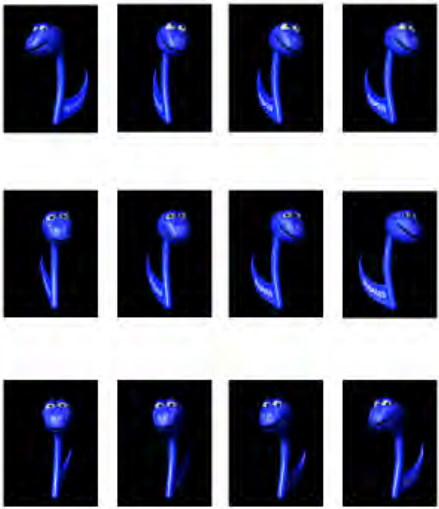
		the edge of the branch and alighting thereon. The seventh still depicts the bird laying down the branch to begin a nest. The eighth to twenty-first stills depict the bird repeating this process to build a complete nest. The twenty-second still depicts the bird sitting on the nest, and the twenty-third still depicts a nest containing three bird eggs.				
NZ	828029		9 16	Mario Gabriel Ltd	E W	2011

NZ	843467	 <p>The trade mark consists of an animated sequence of images, as shown in the representation attached to the application. The first frame shows two flowers in two separate vases being alive, upright and healthy, as well as flies surrounding the flowers and vases. The second frame shows one of the flowers being alive, upright and healthy; whereas the head of the other flower beginning to droop. The third frame shows one of the flowers being alive, upright and healthy; whereas the head of the other flower continuing to droop and noticeably less healthy in appearance than the other flower. The fourth frame shows one of the flowers being alive, upright and healthy; whereas the head the other flower continuing to droop and appears wilted and dying. The fifth frame shows one of the flowers being alive, upright and healthy; whereas the other flower wilted with its head hanging down. The flies surrounding the alive, upright and healthy flower appear dead or dying; whereas the flies</p>	5 9 21	Reckitt Benckiser (Australia) Pty Limited	R	2010
----	--------	--	--------	---	---	------

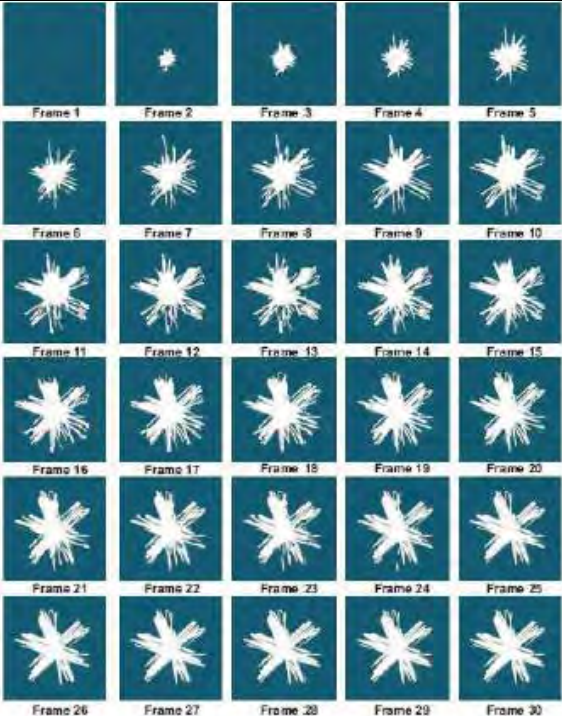
		<p>surrounding the wilted flower appear alive. The final frame shows one of the flowers being alive, upright and healthy; whereas the other flower wilted and appears dead. The flies surrounding the alive, upright and healthy flower appear dead; whereas the flies surrounding the wilted flower appear alive.</p>				
<p>NZ</p>	<p>843284</p>	 <p>This mark consists of an animation, as shown in the representations attached to the application. The animation is displayed in rectangular frames, and opens with a blue background. In frames 2 to 9, segments of line appear, progressing out from a central point in the middle of the frame. The line segments are of unequal length, and move outwards from the centre of the frame in many directions. They appear to be continuously moving, and many of the line segments double back approximately over their first path when they reach</p>	<p>9 16 35 36 38 39 41 42 45</p>	<p>Telecom IP Ltd</p>	<p>R</p>	<p>2013</p>

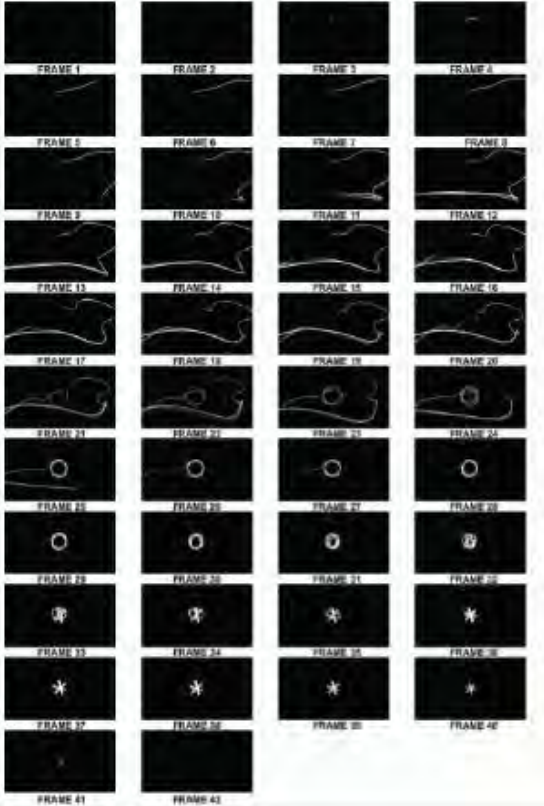
		<p>their full length, crossing back through the centre point where the lines intersect. By frame 9, the size of the area covered by the lines has stabilised. From frames 9 to 30, the lines continue to cross back and forth across the central point, taking slightly different paths each time. Some of the lines' previous paths disappear as new ones are created, with the result that as the animation progresses, the line segments appear to be clustered around three basic axes, which bisect each other at the central point. The lines appear to be in continuous movement throughout the animation</p>				
<p>NZ</p>	<p>846447</p>	 <p>This mark consists of an animation, as shown in the representations attached to the</p>	<p>9 38 42</p>	<p>Telecom IP Ltd</p>	<p>R</p>	<p>2013</p>

	<p>application. The animation is displayed in rectangular frames, and opens with an entirely black background. Between frames 3 and frame 7, a line begins to appear, originating from the middle of the upper half of the screen, and progressing towards the upper right corner of the screen, where it appears to go off the edge of the screen. Between frames 8 and 14, the line re-enters the screen about halfway down the right hand side, and curves in and then out again towards the lower right hand corner of the screen, before curving again and traversing left in a flat curve, exiting the screen again on the left hand side briefly. From frames 15 to 20 the line re-enters slightly below its most recent exit point, crossing over its own path near the left hand side of the screen and travelling towards the centre of the screen. As the line travels, its path moves in a squiggly manner and its trail begins to disappear behind it. Frames 21 to 29 show the line reaching the centre of the screen, where it travels in approximate circles several times. During those frames the end of the line catches up with itself so that the entire length of line is involved in tracing several round shapes approximately over the top of each other. In frames 30 to 35 some of the circles appear to twist three-dimensionally on their axis, so that the line now resembles three groups of round shapes entwined together around the same nucleus. In frames 36 to 38 the circular shapes appear to twist further so that the three groups of circular shapes appear to be viewed side on, visible as flat lines. This gives the appearance of three groups of lines crossing each other at a central point. In frames 39 to 41 the shape shrinks and then disappears in frame 42, leaving a black screen</p>				
--	--	--	--	--	--

NZ	846448	 <p data-bbox="470 957 1265 1356">This mark consists of an animation, as shown in the representations attached to the application. The animation is displayed in rectangular frames, and opens with an entirely black background. In frames 3 and frame 9, a blue line appears, originating from about the middle of the screen. The line moves upward and to the left, before curving down, to the right, curving around below its starting point and then sweeping in a broad curve up and around its starting point, and over far to the left of the frame. From frame 10 to 12, the line curves again towards the right, moving below its previous path in a flat curve until it reaches the midright side of the frame, where it</p>	9 38 42	Telecom IP Ltd	R	2013
----	--------	---	---------	----------------	---	------

		<p>curves down in a tight bend and veers to the left once more. In frames 13 to 16 the line continues to curve left and upwards, crossing its previous path slightly to the right-hand side of the frame, and continuing up and left, then up and right, and curving around its starting point. In frames 17 to 23, the line traces several circular shapes around its original starting point. Meanwhile, its previous path begins to disappear behind it, until in frame 23 the line is only visible in the several circular shapes roughly occupying the same space in the centre of the screen. In frames 24 to 29 the circular shapes appear to twist three-dimensionally on their axis, so that the line now resembles three groups of round shapes entwined together around the same nucleus. In frames 30 and 31 the circular shapes appear to twist further so that the three groups of circular shapes appear to be viewed side on, visible as flat lines. This gives the appearance of three groups of lines crossing each other at a central point. In frames 30 and 31 the lines turn from blue to white.</p>				
--	--	--	--	--	--	--

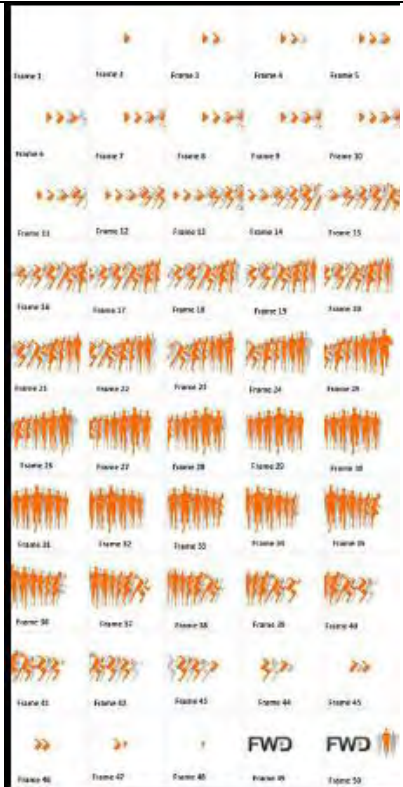

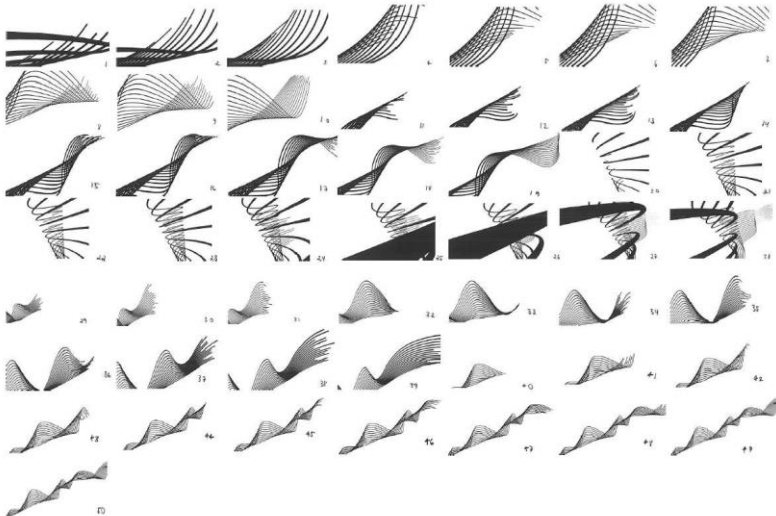
<p>NZ</p>	<p>988424</p>	 <p>The trade mark is an animation, as shown in the representations attached to the application. It is composed of 50 sequences (1 to 50) that lasts 10 seconds in total. The starting point is an orange triangle that multiplies to show an increasing number of orange and grey triangles and triangular arrow devices which start to overlap (frames 1 through to 15); the triangles/arrow devices then appear to gradually turn into a group of runners viewed from the side (frames 16 to 18), then from both the front and from the side (frames 19 to 37), then the runners appear to gradually become orange and grey triangles and triangular arrow devices (frames 38 to 47) and the number of triangles/arrow devices gradually decreases until finally there is a single orange</p>	<p>3 5 7 9 10 12 14 16 18 25</p>	<p>Valdimir Pte</p>	<p>E R</p>	<p>2014</p>
-----------	---------------	---	--	---------------------	------------	-------------

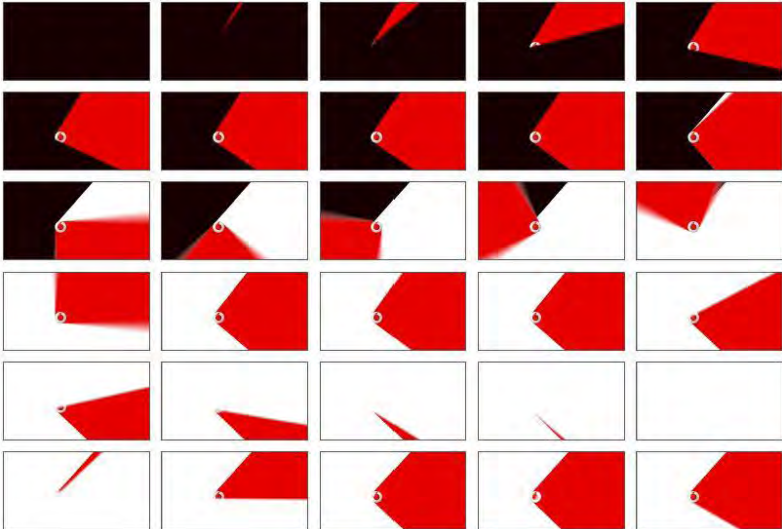

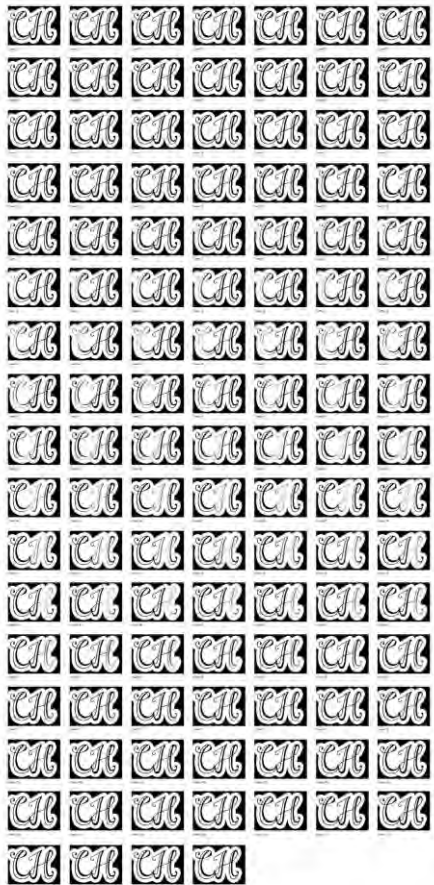
		<p>triangle (frame 48). A FWD logo then appears, leaving the final orange triangle from frame 48 in the center of the letter D in the FWD logo (frame 49). In the final sequence (frame 50), on the right side of the FWD logo, three runners appear viewed from the front, the central runner is orange and two side runners are in grey.</p>				
<p>NZ</p>	<p>995209</p>	 <p>There are 50 frames in the sequence. The first 10 frames show the spirograph moving diagonally away from the viewer from the bottom left of the screen to the top right of the screen. Frames 11 through 19 show the spirograph moving diagonally towards the viewer from the bottom left of the screen to the top right of the screen. Frames 20 through 28 show the spirograph moving away from the viewer to the back right corner of the screen. At frame 25 the perspective of the viewer changes from being underneath the moving spirograph to being above the moving spirograph. Frames 29 through 39 show the spirograph moving diagonally towards the viewer from the bottom left of the screen to the top right of the screen. Frames 40 through 49 show the spirograph moving diagonally away from the viewer from the bottom left of the screen</p>	<p>9 36</p>	<p>IG Group Ltd</p>	<p>R</p>	<p>2014</p>

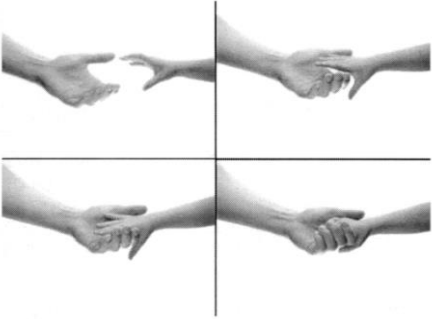

		to the top right of the screen. The final frame shows the full spirograph stretching from the bottom left of the screen to the top right of the screen.				
NZ	1001737	 <p>The mark consists of an animation, as shown in the representations attached to the application. In frames 1 to 8, the animated red rhombus emanates sideways from a central white circle containing a red speech mark. In frames 9 to 18, the red rhombus rotates once clockwise around the central circle. In frames 19 to 25, the red rhombus shuts from top to bottom. In frames 30 to 35, the red rhombus reopens from top to bottom. The black and white backgrounds shown in the animation are not part of the mark and may contain additional material</p>	9 35 38 41	Vodafone Group	E R	2015



NZ	1015646	 <p data-bbox="472 1050 1256 1374">The trademark consists of an animated sequence of images, as shown in the representation. The sequence shows a moving light sweep from left to right over the image, the image being a monogram of the letters C and H. There are 116 frames in the sequence. The first 27 frames in the sequence do not show the effect of the light sweep. Frames 28-57 show the light sweep moving from the left to the right of the image, noticeably over the letter C. Frames 58-72 show the light sweep moving over the centre of the image, noticeably over the left side of</p>	25	C Hoogenboom	R	2015
----	---------	---	----	--------------	---	------

		the letter H. Frames 73-98 show the light sweep moving over the right side of the image, noticeably over the right side of the letter H. Frames 98-116 show no effect of the light sweep on the image				
NZ	1027502	 <p>The mark consists of a motion mark of numerous pictures coming together to form a swirl design above the word "SEAGATE"</p>	9	Seagate Technology LLC	E R	2017
NZ	1059023	<p>This mark consists of an animation, as shown in the 17 representations attached to the application labelled chronologically from frame 1 through to frame 17.</p> <p>The animation is displayed in rectangular frames, and opens in frame 1 with a black background, having a slight crimson yellow and orange graduation at the bottom left hand corner and a faint criss-crossed white lines unequal in length situated in the middle of the screen.</p> <p>From frame 1 to 5 the crimson graduation at the bottom left hand screen brightens and graduates into a yellow and orange haze with three oval flashes of reflective light progressive in a line from the bottom left hand corner of the screen and progressing towards the criss-crossed white lines in the middle of the screen.</p> <p>From frames 6 to 9 the yellow and orange haze and the three oval flashes of reflective light diminish until by frame 10 they are completely gone.</p> <p>From frames 1 to 17 the criss-crossed white lines appear to be continuously drawing themselves, and many of the line segments double back approximately over their first path when they reach their full length, crossing back through the centre point where the lines intersect. By the final frame 17, the size of the area covered by the lines has stabilised. As the animation progresses, the line segments appear to be</p>	6 16 35 36 37	Spark new zealand	R	2018

		clustered around three basic axes, which bisect each other at the central point. The lines appear to be in continuous movement throughout the animation.				
SG	T0501368G		9	Nokia Corporation	E	2008
SG	T0618749B	 <p>The mark is an animated sequence with two flared segments that join in the upper right portion of the mark. During the animation sequence, a geometric object moves up adjacent the first segment and then down adjacent the second segment, while individual chords within each segment turn from dark to light. Stippling shown in the mark is for shading only</p>	9	Microsoft Corporation	E	200

US	75/298415	 <p data-bbox="472 550 1249 687">Oben aus einem Behälter austretende Papierschnipsel / The trade mark consists of the visual appearance of small pieces of paper ejected from the top of the container for applicants goods when the container is opened.</p>	33	De Poil	E W	2000
US	641872	<p data-bbox="472 699 958 766">Münze, die auf harte Oberfläche kreiselt / Coin spinning on a hard surface.</p>	36	Northwestern Bank of Commerce	R W	1988
US	1928423	 <p data-bbox="472 1129 1249 1267">The trademark is a computer generated sequence showing the central element from several angles as though a camera is moving around the structure. The drawing represents four "stills" from the sequence.</p>	9	Twentieth Century Fox Film Corp.	R	1995

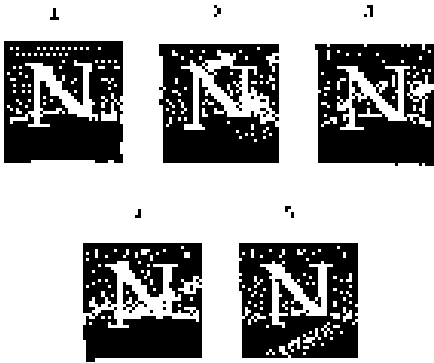
US	1946170	 <p data-bbox="472 405 1249 512">Fontaine eines Motorbootes / Three dimensional spray of water issued from the rear of a jet propelled watercraft and is generated during the operation of the watercraft</p>	12	Yamaha Hatsudoki	R	1996
US	1975999	 <p data-bbox="472 852 1249 1069">The mark consists of a moving image of a flash of light from which rays of light are emitted against a background of sky and clouds. The scene then pans downward to a torch being held by a lady on a pedestal. The word "COLUMBIA" appears across the top running through the torch and then a circular rainbow appears in the sky encircling the lady.</p>	9	Columbia	R	1996

<p>US</p>	<p>2077148</p>	 <p>The mark consists of an animated sequence of images depicting the silhouette of a portion of a planet with an upper case letter "N" straddling the planet and a series of meteorites passing through the scene, all encompassed within a square frame. The animated sequence is displayed during operation of the software.</p>	<p>9</p>	<p>Netscape Communication Corporation</p>	<p>R</p>	<p>1997</p>
<p>US</p>	<p>2092415</p>	 <p>The moving image design mark, comprised of an approximately five second visual sequence, depicts a city skyline, sky and water, enclosed in two concentric circles containing the words "BROADWAY VIDEO". As the city skyline comes into view the words "BROADWAY VIDEO" rotate clockwise within the circles surrounding the city. The image concludes with a red lightening bolt entering the circle and forming</p>	<p>41</p>	<p>Broadway Video Inc.</p>	<p>R</p>	<p>1997</p>

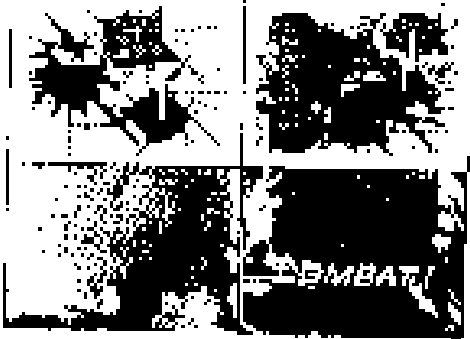

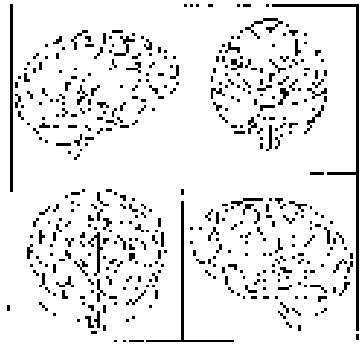
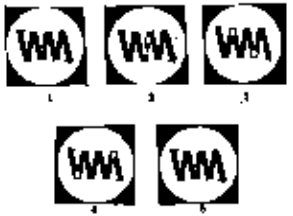
		a "V". The drawing represents four stills from the sequence.				
US	2106424	 <p>Drehende Weltkugel / mark consists of a moving image of a spinning globe.</p>	9	Garmin Corp.	R	1997
US	2126551	 <p>The moving image design mark, comprised of an approximately eight-second visual sequence, depicts a military helmet as though seen through a camera pulling back. The drawing represents four stills from the sequence.</p>	41	ABC Cable and International Broadcast	R	1998
US	2187082	The mark consists of the combination of the sounds of thunder and rain with a strobe representation of lightning.	11	KES Science and Technology Inc.	R	1998

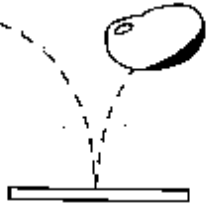
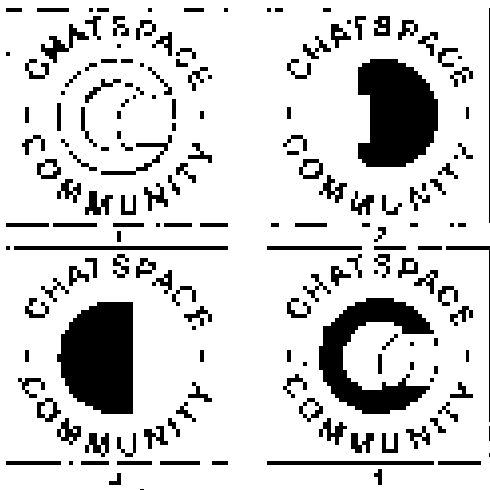
US	2315036	 <p>The mark is a computer-generated sequence showing the central element rotating. The drawing represents four "stills" from the sequence</p>	42	American Association of Neurological Surgeons	R	2000
US	2323892	<p>The mark consists of a pre-programmed rotating sequence of a plurality of high intensity columns of light projected into the sky to locate a source at the base thereof.</p>	11 41	Ballantyne of Omaha Inc.	R	2000
US	2334502	 <p>The mark consists of an animated sequence of images depicting two electrons moving through the stylized, connected letters "W" and "M". The electrons start in the middle of the letters and one moves towards the left arrow while the other moves toward the right arrow. The numbers "1,2,3,4, and 5" are not part of the mark but serve to show the order of the sequence of images.</p>	36	Wattage Monitor Inc.	R	2000

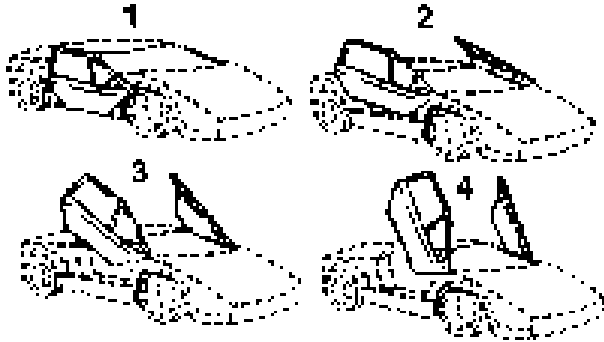
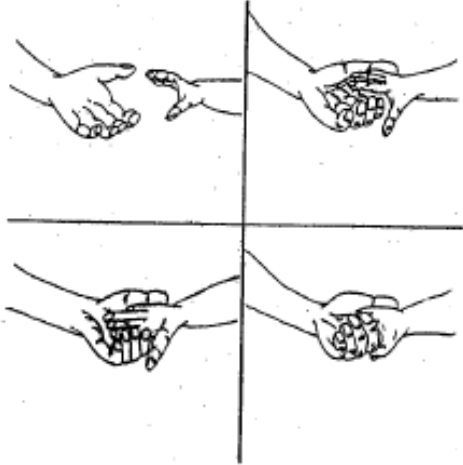

US	2373655	 <p data-bbox="472 432 882 467">Springende Bohne / Jumping bean</p>	9	Ad Astra Engineering Inc.	R	2000
US	2526537	 <p data-bbox="472 1031 1256 1321">The mark consists of an animated sequence of images which is displayed during the operation of the software and during the communication between the users. The three dimensional "C" at the center of the drawing is attached to a hemisphere that rotates 360 degrees clockwise on its vertical axis. The drawing of the mark depicts the first and last frames of the sequence as well as two intermediary frames. The numbering (1,2,3,4) is not a part of the mark and is included only to show the sequence of the frames.</p>	9 38 42	Chatspace Inc.	R	2002



US	2710415	 <p data-bbox="472 662 1261 949">The mark consists of the live visual and motion elements of the The Peabody Duck March as performed at The Peabody Hotels, only one segment of which is depicted in line art in the drawing. The motion elements include the red carpet being rolled out, the appearance of the ducks and uniformed Duckmaster at the elevator door, and the march of the ducks down the red carpet, up the steps, and into the fountain where they begin swimming. The mark also includes the fanfare in reverse sequence</p>	42	Peabody Management, Inc.	R	2003
US	2756210		36	National City Corp.	R	2003

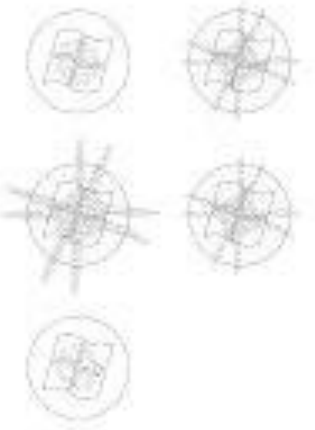

US	2793439		12	Automobili Lamborghini	R	2003
US	3181051	 <p data-bbox="472 1062 1245 1278">The trademark consists of an image of a man's hand and a child's hand which appear in sequence, whereby the man's hand and the child's hand converge in the positions illustrated in the top left and right figures, and the man's hand and child's hand touch and clasp in the positions illustrated in the bottom left and right figures respectively</p>	9 38 41	Nokia Corp.	R	2006

US	3207027	 <p>Besteht aus der Darstellung eines bewegten Bildes in Form einer animierten Bildsequenz, die einen quadratischen Punkt mit abgerundeten Ecken und die Buchstaben Y, E, L und L zeigt. Nachdem anfänglich ein leerer quadratischer Punkt mit abgerundeten Ecken für wenige Sekunden angezeigt wird, erscheinen dann die Buchstaben Y, E, L und L in schneller Folge in diesem quadratischen Punkt, so dass sich das Wort YELL ergibt. Die Buchstaben werden durch die kurze Anzeige des leeren Punktes voneinander getrennt. Die Darstellung besteht aus acht Einzelbildern, aus denen sich die Sequenz zusammensetzt.</p> <p>The mark consists of an animated visual sequence depicting a square dot with rounded corners and the letters Y, E, L, and L. After the initial display of the empty square dot with rounded corners for a few seconds, the letters Y, E, L, and L appear in quick succession inside the square dot, so as to spell the word YELL. The letters are separated by a brief display of the empty square dot. The drawing consists of eight stills that make up the sequence.</p>	9 16 35 36 37 38 39 41 42	Yell Ltd	E R	2007
US	3307778	 <p>The mark consists of a series of movements depicted as follows: Step 1 shows the beginning of the check mark element being drawn, as well as the beginning of the circle element being drawn; and Step 2 shows the check mark element continuing to be drawn and</p>	9 35 36 41 42	VeriSign Inc.	E R	2007



		<p>the completion of the circle element; and Step 3 shows the complete circle design, the check mark element continuing to be drawn through the addition of square elements moving into place to form the pixelized end of the check mark; and Step 4 shows the complete circle element, the complete check mark element, and the start of the capsule element being drawn as it extends from the right-hand side of the circle element at the top and bottom; and finally, Step 5 shows the complete mark consisting of the circle element, check mark element (including the pixelized end of the check mark), capsule element extending off of the right-hand side of the circle element framing the wording "VERISIGN SECURED"</p>				
US	3407062 78832765	 <p>The mark consists of an animated sequence with two flared segments that join in the upper right portion of the mark. During the animation sequence, a geometric object moves up adjacent the first segment and then down adjacent the second segment while individual chords within each segment turn from dark to light.</p>	9	Microsoft Corporation	E R	2008



US	3517112	 <p>The mark consists of an animation mark featuring a flag image with a circle background, which illuminates during the animation sequence as shown in the stippling in the various panels of the drawing</p>	9	Microsoft Corporation	E R	2008
US	3983642 79086645	 <p>The mark is a motion mark that consists of three blue lines that continuously turn counterclockwise. One complete revolution takes approximately 12 seconds. The black is meant to show background, and is not claimed as a feature of the mark.</p>	10	Hamilton Mediical AG	E R	2011
US	3983647 79086759	 <p>The mark is a motion mark consisting of a flashing circle. As the circle appears, the lines become clearer, and a circle takes form before disappearing again. The entire cycle has a duration between 3</p>	10	Hamilton Medical AG	E R	2011



		and 4 seconds				
US	4148517 85053101	 <p>The mark consists of a motion mark of an animated graphic representation of a dog-eared (turned over) corner of a piece of perforated material.</p>	17	Clear Focus Imaging Inc.	R C	2012 2019
US	4529837 85111993	The mark is a motion mark consisting of the word "GENERATION", the letters of which move to form the word "GREENATION"	35	Green and You Robert E. Weinberg	E R	2013
US	3966444	 <p>The mark is a motion mark, which consists of an animation of a rotating ring of nine circular emblems consisting of: a sheet of paper and a pen; an airplane; a computer mouse; a shipping box; three stylized waves; a shipping crate; a road; a world globe; and a map of the contiguous United States; each shown in white on a blue circle, the rotating ring shown in perspective with the emblems increasing in</p>	35 39	Service By Air Inc	E R C	2012 2017

US	85189966	<p>size as they rotate toward the front of the ring.</p>  <p>The mark consists of green smoke push motion mark Description: Person starts off with an electronic cigarette close to his/her face or chest (either right after taking a puff or just holding it right in front of or next to his/her body or face) with the arm folded at the elbow close to or against the body. The person then extends the hand with the cigarette towards the camera, making sure that the electronic cigarette is moving towards the camera in a generally straight path (allowing the camera to keep focus on the cigarette at all times throughout the motion). The person also twists the hand, if necessary, so that -- as the hand is extended out -- the cigarette's entire length and its logo will be facing the camera. The motion ends when the person's hand is fully extended towards the camera, and the cigarette and the hand take up most of the camera's viewing screen. At this point the person stops moving and freezes the hand, so that the camera can zoom in and focus clearly on the logo of the cigarette</p>	34	Sorsa Holdings inc Corp.	E W	2012
US	4043554 85193427	 <p>The mark consists of images in motion in a 3-2-1 sequence, namely, a sensor moving up and down.</p>	9	Mikrosoft Corp.	E R C	2011 2018

US	85323464	 <p>The mark is a motion mark. The mark consists of the stylized wording, "YOGA LIVE LINK", having the term "LIVE" above the term "LINK" so that the stacked terms "LIVE" and "LINK" are the same font size as the term "YOGA", and the motion mark consisting of a moving graphic of a yoga practitioner positioned to the right of the wording "YOGA LIVE LINK", in which the practitioner moves through a series of "yoga" poses, beginning face forward in a Mountain Pose in which the practitioner is standing straight with hands at sides, moving to a Warrior II Pose in which the practitioner is standing with one knee bent and the other extended straight behind while both arms are raised and parallel to the floor, transitioning to a Half Moon Pose without touching the floor with either hand while the practitioner is standing on one leg while raising the other leg parallel to the floor and keeping the head and torso in line with the raised leg with the arms extended and perpendicular to the floor, moving to another Warrior II Pose during which a computer fades into the background directly behind the practitioner, returning to a Mountain Pose then turning around, stepping from the background into the computer screen, and ending the series of movements by sitting face forward in Siddhasana Pose in which the practitioner is sitting cross legged with hands resting upon knees inside the computer screen</p>	41	Virtual Yoga Club	E W	2013
----	----------	--	----	-------------------	-----	------

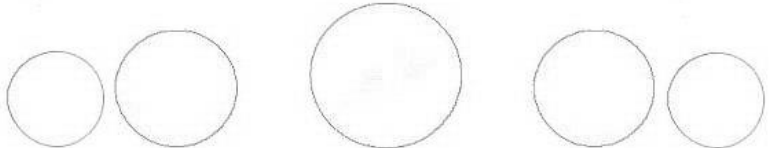
US	4483294 85480779	 <p>The mark consists of the wording "PERFORMANCE" in black, and below and offset to the right, the wording "BUILT" in red; Preceding "BUILT" are three red horizontal motion marks, including a top motion mark which bends sharply in the opposite direction and overlaps into the wording "PERFORMANCE"</p>	6	YTL International GmbH	E R	2014
US	85581031	 <p>The mark consists of a motion mark. The image file shown is the initial point of the movement and depicts a ball comprising alternating white and black strips. The word "Bocbee" is shown in the center of the middle white strip. The letters "o", "c" and the first letter "e" are shown in black. The letters "B", "b" and the second letter "e" are shown in red, with the latter showing two small white horizontal stripes across the top of the letter "e". The word "Bocbee" is shown with white edging. The surface of the ball has a hexagonal pattern. The circular ball rotates 360 degrees on its vertical axis and then elongates along its horizontal axis and then rotates 360 degrees again</p>	9	Bo Holdings Bee Ltd Corp.	E W	2014

US	4471608 85609301	 <p>The mark consists of a motion mark that consists of a silver disc containing a black ring around its outer edges. A white light that fades to a purple trail moves in a clockwise rotation around the ring. Inside the ring is the outline of a microphone, with a black base and a purple body that has a black shadowing effect to the lower right. The black box around the ring is not claimed as a feature of the mark, and is intended to show background only</p>	9 28 35 41 42	Apple Inc. Corp.	E R	2014
US	85700769	 <p>The mark is a motion mark. The mark consists of the word "ASK" in black letters in a red rectangle flashing open</p>	41	The meth Project Fondation Corp	E W	2013
US	85723502	 <p>The mark consists of A MOTION MARK CONSISTING OF CIRCLES OF SIZES DECREASING TOWARD THE MARGINS, WHICH CIRCLES ARE MOVABLE IN EITHER DIRECTION BY THE USER</p>	35	Happen LLC	E W	2016

US	3972865	 <p>The mark is a motion mark. The mark consists of a continuous wave-like design comprised of repeating designs of a solid white dot inside a stylized "V" on an orange background, both right side up and upside down, in motion which eventually morphs into the words "VONAGE SOUNDS GOOD" with the word "VONAGE" in white with a solid blue dot inside the "V" and the words "SOUNDS GOOD" in blue underneath</p>	38	Vonage marketing LLC	R	2011
US	3983770	 <p>The mark is a motion mark consisting of a continuous wave-like design comprised of repeating designs of a solid dot inside a stylized "V", both right side up and upside down. The mark moves horizontally, appearing similar to a visual depiction of sound waves</p>	38	Vonage marketing LLC	R	2011

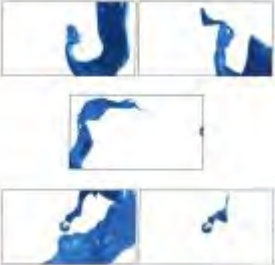
US	4033205	 <p>The mark is a motion mark - five frames of which are shown in the drawing - which runs within a time frame of approximately 6 seconds. In the mark, a stream of blue-colored liquid moves into the screen from the upper right-hand corner, down the right side of the screen, curves up toward the middle of the screen, and then continues on toward the upper left-hand corner. Once at the upper left of the screen, the liquid then curves down and moves along the left side of the screen before curving to the right and moving along the bottom of the screen. At this point, a sphere with a blue-colored center appears from the right-hand side of the frame, and begins to move left toward the center of the image. As the sphere appears, the liquid curves up toward the upper right-hand corner of the screen, before curving sharply back toward the center of the screen. The liquid then pours around and into the sphere at the center of the screen. Once the liquid has poured into the sphere, the sphere increases in size, and moves to the upper-center of the screen. The black, white, and gray in the image are not claimed as a feature of the mark, and are meant to represent background, outlining, shading and/or transparent areas only.</p>	9 38 41	Sony Ericsson Mobile	R	2011
----	---------	---	---------	----------------------	---	------

US	4033206	 <p>color(s) red is/are claimed as a feature of the mark. The mark is a motion mark - five frames of which are shown in the drawing - which runs within a time frame of approximately 6 seconds. In the mark, a stream of cherry red-colored liquid moves into the screen from the upper right-hand corner, down the right side of the screen, curves up toward the middle of the screen, and then continues on toward the upper left-hand corner. Once at the upper left of the screen, the liquid then curves down and moves along the left side of the screen before curving to the right and moving along the bottom of the screen. At this point, a sphere with a cherry red-colored center appears from the right-hand side of the frame, and begins to move left toward the center of the image. As the sphere appears, the liquid curves up toward the upper right-hand corner of the screen, before curving sharply back toward the center of the screen. The liquid then pours around and into the sphere at the center of the screen. Once the liquid has poured into the sphere, the sphere increases in size, and moves to the upper-center of the screen. The black, white, and gray in the image are not claimed as a feature of the mark, and are meant to represent background, outlining, shading and/or transparent areas only</p>	9 38 41	Sony Ericsson Mobile	R	2011
----	---------	--	---------	----------------------	---	------

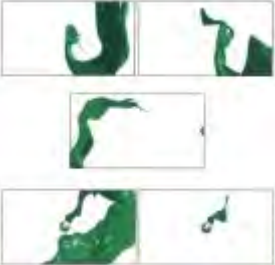
US	4033207	 <p>color(s) green is/are claimed as a feature of the mark The mark is a motion mark - five frames of which are shown in the drawing - which runs within a time frame of approximately 6 seconds. In the mark, a stream of green-colored liquid moves into the screen from the upper right-hand corner, down the right side of the screen, curves up toward the middle of the screen, and then continues on toward the upper left-hand corner. Once at the upper left of the screen, the liquid then curves down and moves along the left side of the screen before curving to the right and moving along the bottom of the screen. At this point, a sphere with a green-colored center appears from the right-hand side of the frame, and begins to move left toward the center of the image. As the sphere appears, the liquid curves up toward the upper right-hand corner of the screen, before curving sharply back toward the center of the screen. The liquid then pours around and into the sphere at the center of the screen. Once the liquid has poured into the sphere, the sphere increases in size, and moves to the upper-center of the screen. The black, white, and gray in the image are not claimed as a feature of the mark, and are meant to represent background, outlining, shading and/or transparent areas only.</p>	9 38 41	Sony Ericsson Mobile	R	2011
----	---------	--	---------	----------------------	---	------

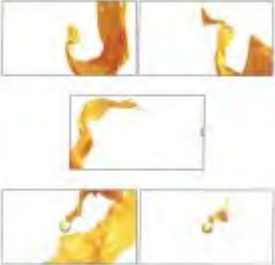

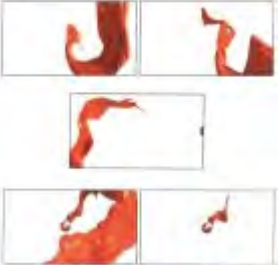
US	4033208	 <p>color(s) orange is/are claimed as a feature of the mark. The mark is a motion mark - five frames of which are shown in the drawing - which runs within a time frame of approximately 6 seconds. In the mark, a stream of orange-colored liquid moves into the screen from the upper right-hand corner, down the right side of the screen, curves up toward the middle of the screen, and then continues on toward the upper left-hand corner. Once at the upper left of the screen, the liquid then curves down and moves along the left side of the screen before curving to the right and moving along the bottom of the screen. At this point, a sphere with a orange-colored center appears from the right-hand side of the frame, and begins to move left toward the center of the image. As the sphere appears, the liquid curves up toward the upper right-hand corner of the screen, before curving sharply back toward the center of the screen. The liquid then pours around and into the sphere at the center of the screen. Once the liquid has poured into the sphere, the sphere increases in size, and moves to the upper-center of the screen. The black, white, and gray in the image are not claimed as a feature of the mark, and are meant to represent background, outlining, shading and/or transparent areas only.</p>	9 38 41	Sony Ericsson Mobile	R	2011
----	---------	--	---------	----------------------	---	------

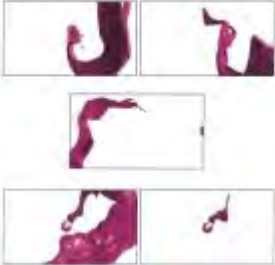
US	4033209	 <p>color(s) red is/are claimed as a feature of the mark. The mark is a motion mark - five frames of which are shown in the drawing - which runs within a time frame of approximately 6 seconds. In the mark, a stream of red-colored liquid moves into the screen from the upper right-hand corner, down the right side of the screen, curves up toward the middle of the screen, and then continues on toward the upper left-hand corner. Once at the upper left of the screen, the liquid then curves down and moves along the left side of the screen before curving to the right and moving along the bottom of the screen. At this point, a sphere with a red-colored center appears from the right-hand side of the frame, and begins to move left toward the center of the image. As the sphere appears, the liquid curves up toward the upper right-hand corner of the screen, before curving sharply back toward the center of the screen. The liquid then pours around and into the sphere at the center of the screen. Once the liquid has poured into the sphere, the sphere increases in size, and moves to the upper-center of the screen. The black, white, and gray in the image are not claimed as a feature of the mark, and are meant to represent background, outlining, shading and/or transparent areas only.</p>	9 38 41	Sony Ericsson Mobile	R	2011
----	---------	---	---------	----------------------	---	------

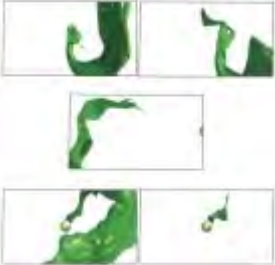

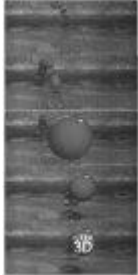
US	4033210	 <p>color(s) purple is/are claimed as a feature of the mark. The mark is a motion mark - five frames of which are shown in the drawing - which runs within a time frame of approximately 6 seconds. In the mark, a stream of purple-colored liquid moves into the screen from the upper right-hand corner, down the right side of the screen, curves up toward the middle of the screen, and then continues on toward the upper left-hand corner. Once at the upper left of the screen, the liquid then curves down and moves along the left side of the screen before curving to the right and moving along the bottom of the screen. At this point, a sphere with a purple-colored center appears from the right-hand side of the frame, and begins to move left toward the center of the image. As the sphere appears, the liquid curves up toward the upper right-hand corner of the screen, before curving sharply back toward the center of the screen. The liquid then pours around and into the sphere at the center of the screen. Once the liquid has poured into the sphere, the sphere increases in size, and moves to the upper-center of the screen. The black, white, and gray in the image are not claimed as a feature of the mark, and are meant to represent background, outlining, shading and/or transparent areas only</p>	9 3841	Sony Ericsson Mobile	R	2011
----	---------	---	--------	----------------------	---	------

US	4033211	 <p>color(s) green is/are claimed as a feature of the mark The mark is a motion mark - five frames of which are shown in the drawing - which runs within a time frame of approximately 6 seconds. In the mark, a stream of lime green-colored liquid moves into the screen from the upper right-hand corner, down the right side of the screen, curves up toward the middle of the screen, and then continues on toward the upper left-hand corner. Once at the upper left of the screen, the liquid then curves down and moves along the left side of the screen before curving to the right and moving along the bottom of the screen. At this point, a sphere with a lime green-colored center appears from the right-hand side of the frame, and begins to move left toward the center of the image. As the sphere appears, the liquid curves up toward the upper right-hand corner of the screen, before curving sharply back toward the center of the screen. The liquid then pours around and into the sphere at the center of the screen. Once the liquid has poured into the sphere, the sphere increases in size, and moves to the upper-center of the screen. The black, white, and gray in the image are not claimed as a feature of the mark, and are meant to represent background, outlining, shading and/or transparent areas only</p>	9 38 41	Sony Ericsson Mobile	R	2011
----	---------	---	---------	----------------------	---	------

US	4058875	 <p>The mark is a motion mark. The moving image features a bouncing ball bouncing across a room. During the moving image sequence, the ball, which is at the back of the room, begins to bounce forward in a slow, animated arc-like motion, with a tail of balls of diminishing sizes trailing behind signifying an exaggerated bouncing movement, moving first to the left and then reversing direction to the right on the first bounce. The ball grows increasingly larger in circumference with each bounce as the bouncing movement propels it forward on the screen. The second bounce propels the ball directly forward, with the ball growing very large, almost filling the screen until it impacts with the screen, stopping the forward movement, causing the ball to bounce off the screen, propelling it backwards into a bounce that then propels the ball into a slightly right and forward motion. At this point in the sequence, the ball appears to be fixed in mid-air, with a tail of balls of diminishing sizes extending from the left of the ball towards the floor in an arc. The moving image sequence concludes with the ball spinning to the right, revealing the words "INTRU 3D" written across the ball. The duration of the moving image is approximately six seconds. The drawing represents five stills from the moving sequence, showing the appearance, direction and movement of each bounce.</p>	9 41	Intel Corp	R	2011
----	---------	---	------	------------	---	------



US	4059063		<p>The mark consists of a sound and motion mark that begins as a spinning circle, wherein the circle is surrounded by a black inner border and a white outer border. The inside of the circle contains a blue background against which are the busts of two men depicted in caricature form, with pink skin, black hair and features, white shirts, and black jackets and ties. The circle starts out small and rotates clockwise while increasing in size. While the circle spins, there is the sound of an object zooming closer with a Doppler shift. The circle then stops spinning, and the man on the left says "JIB", then the man on the right says "JAB", after which the word "JIBJAB" fades in below the two men, with the upper portion of the letters in white, and the lower portion fading into blue. The letters have a black shadowing effect, and are bordered in white. As the wording appears, chimes are heard. The black surrounding the mark in the drawing is meant to show background, and is not claimed as a feature of the mark</p>	38	JibJab Media Inc.	R	2011
US	4059064		<p>The mark consists of a sound and motion mark that begins as a spinning circle, wherein the circle is surrounded by a black inner border and a white outer border. The</p>	41	JibJab Media Inc	R	2011



		inside of the circle contains a blue background against which are the busts of two men depicted in caricature form, with pink skin, black hair and features, white shirts, and black jackets and ties. The circle starts out small and rotates clockwise while increasing in size. While the circle spins, there is the sound of an object zooming closer with a Doppler shift. The circle then stops spinning, and the man on the left says "JIB", then the man on the right says "JAB", after which the word "JIBJAB" fades in below the two men, with the upper portion of the letters in white, and the lower portion fading into blue. The letters have a black shadowing effect, and are bordered in white. As the wording appears, chimes are heard. The black surrounding the mark in the drawing is meant to show background, and is not claimed as a feature of the mark				
US	4059071	 <p>The mark consists of a sound and motion mark that begins as a spinning circle, wherein the circle is surrounded by a black inner border and a white outer border. The inside of the circle contains a blue background against which are the busts of two men depicted in caricature form, with pink skin, black hair and features, white shirts, and black jackets and ties. The circle starts out small and rotates clockwise while increasing in size. While the circle spins, there is the sound of an object zooming closer with a Doppler shift. The circle then stops spinning, and the man on the left says "JIB", then the man on the right says "JAB", after which the word "JIBJAB" fades in below the two men, with the upper portion of the letters in white, and the lower portion fading into blue. The letters have a black shadowing effect, and are</p>	9	JibJab Media Inc	R	2011

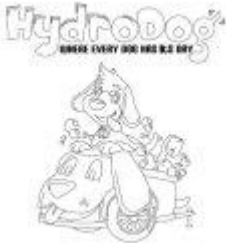

		bordered in white. As the wording appears, chimes are heard. The black surrounding the mark in the drawing is meant to show background, and is not claimed as a feature of the mark				
US	4141223	 <p>The mark is a motion mark. The mark consists of a smiley face comprised of two ovals for eyes, and a curved line for a smile, with a smaller curved line on the left side of the smile representing a smile line. To the upper right of the smiley face is a speech balloon. The ovals of the smiley face turn into small curved lines, representing the eyes blinking.</p>	9	ECR Software Corp	R	2012
US	4148517	 <p>The mark is a motion mark that begins with the outline of a city skyline. At the upper-right corner of the design, the corner gets turned over as if the image were a dog-eared piece of paper or other flat material. The other side of the turned-over corner reveals a perforated mesh material design</p>	17	Clear Focus Imaging	R	2012

US	4196080 (supplemental)	 <p>The mark is a motion mark consisting of three blue, arched lights. The smallest, inner arch lights up first, followed by the middle and then the outer arch. The inner arch then goes dark, followed by the middle and then the outer arch. The sequence then repeats. The vacuum cleaner images are meant to show the location of the mark on the goods, and are a feature of the mark.</p> <p>Type of Mark</p>	7	Zenith Technologies Inc.	E R	2012
----	---------------------------	---	---	--------------------------	-----	------

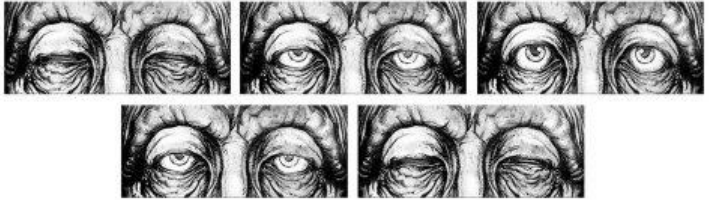
US	4232784	 <p>The mark is a motion mark. The mark consists of an animation of a golfer striking a ball off of a tee. The tee kicks away as the ball is struck, and as the ball soars through the air, the golfer disappears. The wording "FRYS COM" appears and the ball bounces to become the dot between the wording. The word "OPEN" swooshes in, followed by a tail from left to right, underneath the wording "FRYS.COM."</p>	36 41	Fry's electronics Inc.	E R	2012
US	4241996	 <p>The mark consists of a dog with a collar bearing the initial "H" perched in a soapy tub with a scrub brush, the tub being a two-wheeled trailer with one end shaped like the dog's face and the other end having a tail and a trailer hitch, below the word Hydrodog, with a capital H and a capital D, with motion marks around the tip of the letter G to suggest wagging like a tail, with the tagline WHERE EVERY DOG HAS Its DAY, with the t in "its" lower case</p>	3 5 12 35 44	Hydrodog Holding LLC	E R	2012

US	4384117	 <p>The mark consists of a motion mark featuring six freeze frames depicting a foggy screen transitioning to a clear screen via a peeling effect, starting from the left-hand corner moving diagonally to the lower right-hand corner, concluding with a fog-free screen.</p>	5	MSD Consume Care Inc	R	2013
US	4426054	 <p>The mark is a motion mark. The mark consists of an animation of three stylized letters "O", "I", "C" with eyelids blinking and rotating eyes inside the stylized letters "O" and "C" with both eyes finally moving to the right inside the stylized letter "C"</p>	41	OIC Books LLC	R	2013
US	4451827	 <p>The mark is a motion mark. The mark consists of an animation of three stylized letters "O", "I", "C" with eyelids blinking and rotating eyes inside the stylized letters "O" and "C" with both</p>	38	OIC Books LLC	R	2013

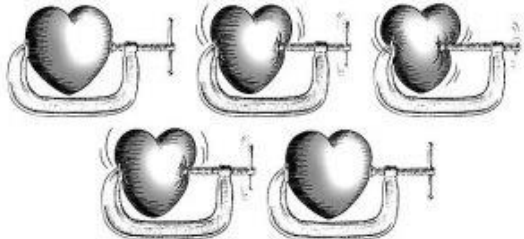

		eyes finally moving to the right inside the stylized letter "C".				
US	4451828	 <p>The mark is a motion mark. The mark consists of an animation of three stylized letters "O", "I", "C" with eyelids blinking and rotating eyes inside the stylized letters "O" and "C" with both eyes finally moving to the right inside the stylized letter "C".</p>	9	OIC Books LLC	R	2013
US	4455172	 <p>The mark consists of a motion mark. The mark consists of an animation presented in a lenticular label affixed to the goods. The animation consists of a depiction of eyes opening and closing. The drawing of the mark includes five freeze frames showing various points in the movement. The stippling is for shading purposes only.</p>	33	Switchcraft LLC	R	2013
US	4470895	 <p>The mark consists of a motion mark. The mark consists of an animation presented in a lenticular label affixed to the goods. The animation consists of a depiction of a spinning bottle which spins completely around. The bottle is depicted in contrasting images to convey motion. The drawing of the mark includes three freeze</p>	33	Switchcraft LLC	R	2014

		frames showing various points in the movement. The stippling is for shading purposes and to convey movement only.				
US	4471608	 <p>The mark consists of a motion mark that consists of a silver disc containing a black ring around its outer edges. A white light that fades to a purple trail moves in a clockwise rotation around the ring. Inside the ring is the outline of a microphone, with a black base and a purple body that has a black shadowing effect to the lower right. The black box around the ring is not claimed as a feature of the mark, and is intended to show background only.</p>	9 35 43 45	Apple Inc.	R	2014
US	4483294	 <p>The mark consists of the wording "PERFORMANCE" in white, and below it, the wording "BUILT" in red; Preceding "BUILT" are three red horizontal lines including a top motion mark which bends sharply in the opposite direction to the wording "PERFORMANCE"; the black background is not a feature of the mark.</p>	6	YTL int	R	2014
US	4542089	 <p>The mark consists of an animation of an elderly man with hair balding, a head mirror on his forehead, a large nose, eyes wide open, a mouth with an open tongue and bottom teeth, wearing a lab coat with three buttons and pens in his pocket. The man has a</p>	41	S Mills	R	2014

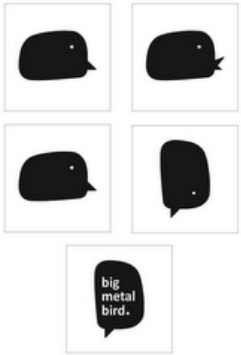

		stethoscope around his neck and is holding in his left hand a clipboard with paper with "Rx". In his right hand, he is holding a briefcase/medical bag. He has one skinny leg visible, standing on a shadow. The wording "THEGOALDOCTOR.COM" is written in all capital letters with no space in between words. The "M" is a picture of buttocks with a dot and the injection site from an animated syringe. The wording "SUCCESS WITHOUT A PRESCRIPTION" appears below the wording				
US	85976881	 The mark consists of the wording "PERFORMANCE" in black, and below and offset to the right, the wording "BUILT" in red; Preceding "BUILT" are three horizontal motion marks , including a top motion mark which bends sharply in the opposite direction and overlaps into the wording	7	YTL int.	E W	2012
US	4711266 86338060	 The mark consists of a motion mark. The mark consists of an animation presented in a lenticular label affixed to the goods. The animation consists of a depiction of a heart being squeezed by a clamp. The drawing of the mark includes five freeze frames showing various points in the movement. The stippling is for shading purposes only	33	Switchcraft llc	E R	2015

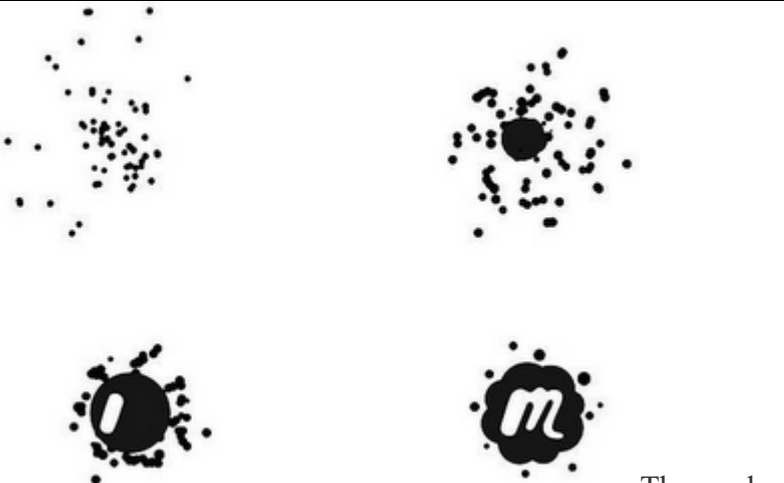
US	5166921	 <p data-bbox="472 411 1258 1078">The mark consists of a motion mark in color. The nature of the motion is that of a red robot with yellow eyes running back and forth in a zigzag movement across a landscape, starting in the background and ending in the foreground. The duration of the motion is approximately 7 seconds. The stills in the sequence are spaced approximately 1 second apart. The stills are arranged consecutively from the beginning to end of sequence. The stills follow a progression from the top left (1st still) to the bottom center (5th still), moving from left to right across each row and then down to the next row. The precise sequence of the stills is as follows: In the 1st still, the robot is shown running across a landscape in a left-to-right direction. In that still, as in the others in the sequence, the landscape is grassy and white and yellow clouds are visible in the background sky. The background and landscape are mostly black, but some grass in the foreground is green and the background sky is shown at sunset. In the 2nd still, the robot is shown running across the landscape in a right-to-left direction and closer to the foreground. The 3rd still shows the robot entering the frame from the left and turning towards the viewer. The 4th still shows the robot moving into an upright, forward-facing position. The head, torso and arms of the robot are visible. In the 5th still, the robot faces toward the viewer, with the head, torso and arms of the robot visible, closer to the viewer, and ends the animation</p>	41	Bap Robot IP	R	2017
----	---------	---	----	--------------	---	------

US	5187557	 <p>The mark consist of a motion mark. The mark transitions from a bird-like image with its beak closed (fig. 1 top left) to a bird-like image moving its beak open (fig 2 top right) and closed (fig. 3 middle left) with the image then rotating clockwise into a speech or thought bubble image shaped like an airplane passenger window (fig. 4 middle right) into which the words "big metal bird" appear in sequence from top to bottom with a "." appearing after "bird" (fig. 5 bottom middle). The squares are not part of the mark but used only to separate the freeze frames showing various points of movement.</p>	41	United Airlines Inc.	R	2017
----	---------	---	----	----------------------	---	------

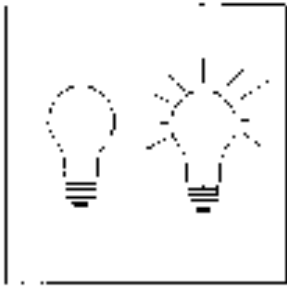
US	5536323	 <p data-bbox="477 630 1240 767">The mark is a motion mark. The mark consists of an animation of a swarm of dots that circle and move to create a designed splash of ink with a stylized letter "M" at the center.</p>	41	Meetup Inc	R	2018
US	86929886	 <p data-bbox="477 1268 1254 1372">The mark consists of a motion mark in color. The nature of the motion is that of the word "Google" appearing from left to right, by letter, respectively in blue,</p>	9 35 39 41 42 43 45	Google Inc.	E O	2019

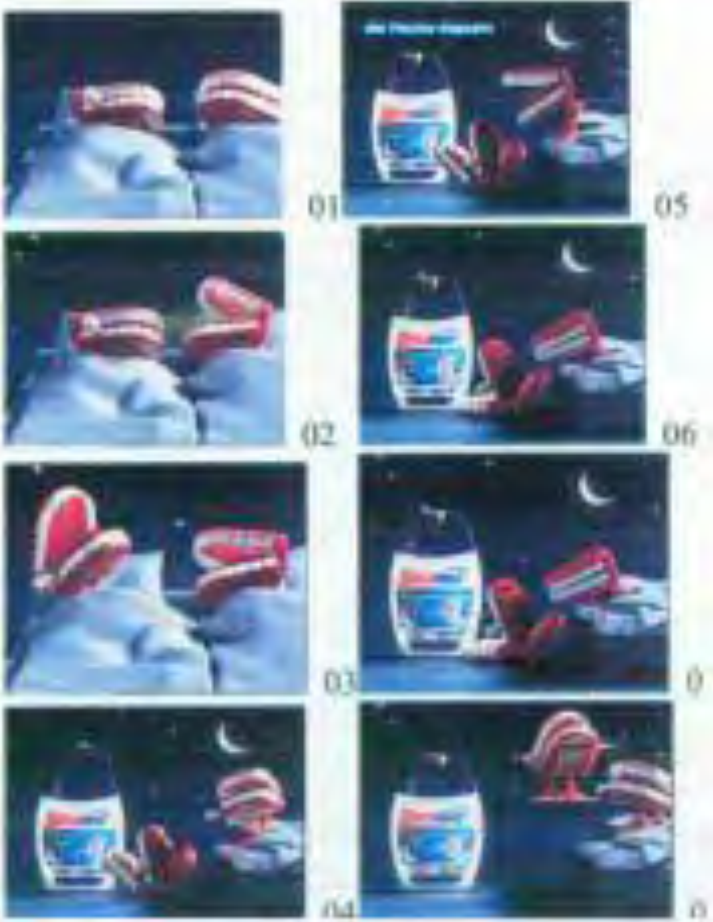

		red, yellow, blue, green and red which dissolves into four small solid colored circles of, from left to right, blue, red, yellow and green which slightly undulate then dissolve into four short vertical lines of differing lengths which are, from left to right, blue, red, yellow and green, forming the image of an equalizer. The vertical lines dissolve back into four small solid colored circles of, from left to right, blue, red, yellow and green which sharply bounce and come to a rest, ending the animation.				
US	76273594	 <p>A moving image design mark comprised of an animate visual sequence of the repetitive motion of a light bulb image flashing off and on. The drawing represents two stills from the visual sequence depicting the alternating images of a plain light bulb without rays of light emanating from the bulb and the same light bulb with rays of light emanating from the bulb. The alternating sequence represents the off and on action of a flashing light bulb.</p>	16	US Optical Merchants Inc.	E W	2004

US	86494383	 <p>The mark consists of a motion mark of numerous pictures coming together to form a swirl design above the word "SEAGATE"</p>	9	Seagate technology LLC	E W	2017
US	87732746	<p>The mark consists of a motion. First, there is a light blue rectangle on the bottom. Then, a small dark blue square rises from the bottom on the far right of the light blue rectangle, and together they form a row. Then, three blue rectangles of varying heights and shading move and expand from right to left, so that they are positioned in ascending order above the row comprised of the lighter blue rectangle and dark blue square.</p>	36	Citigroup	E	2019
WO	682177	<p>Marque consistant dans la représentation d'une main, les trois doigts centraux repliés et le pouce et l'auriculaire étendus vers le haut figurant un mouvement à traits minces sur fond vide; dans le poignet l'élément verbal LA MAGGIOLINA en caractères moulés majuscules, à l'exception de l'article LA en caractères moulés majuscules, à l'exception de l'article LA en caractères italiques à trait mince sur fond vide.</p>	14 16 25	Al.mi S.r.L	R	1997
WO	820269	 <p>The mark consists of an animation created by showing the pictures in a consecutive manner.</p>	9 38 41	Nokia Corp.	R	2003

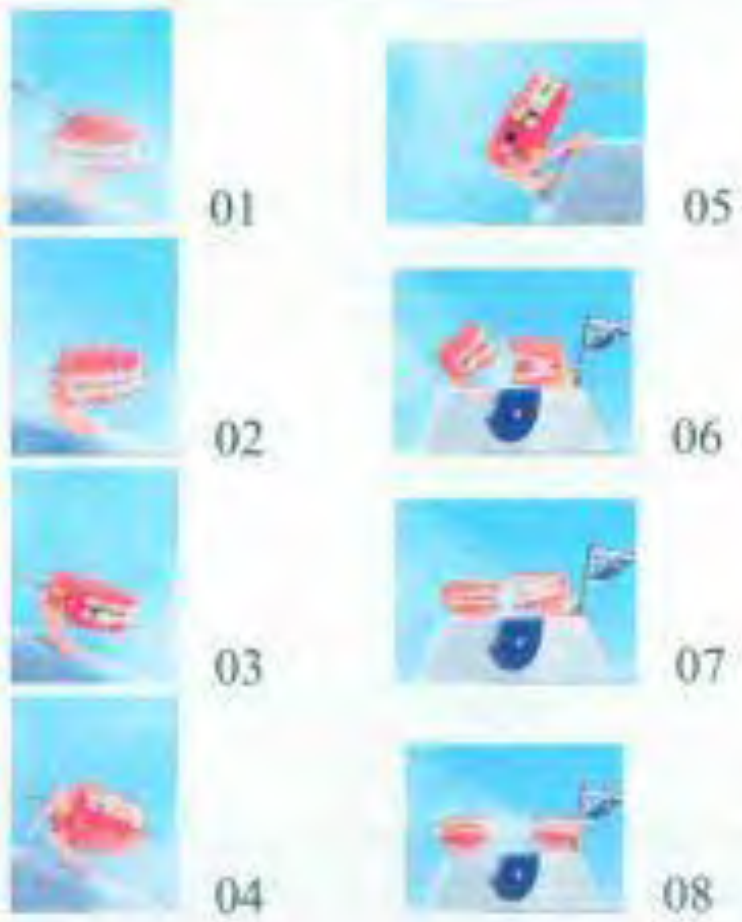
WO	882673	 <p data-bbox="472 1106 1258 1319">The undermentioned mark concerns a moving trademark from which we attach 6 two-dimensional reproductions as well as one larger picture; the eight pictures are represented in ascending order (1 - 8) with the following pauses (in seconds) between the single pictures: 1-2=2:17, 2-3=0:21, 3-4=3:23, 4-5=1:19, 5-6=1:13, 6-7=0:13, 7-8=0:04.</p>	3 5 21	Henkel KG aA	R	2006
----	--------	---	--------	--------------	---	------

WO	882680	 <p data-bbox="481 1117 1220 1252">The undermentioned concerns a moving trademark of which eight pictures are represented in ascending order (1-8) with the following pauses between the single pictures: 1-2=0:04, 2-3=1:14, 3-4=0:22, 4-5=1:19, 5-6=2:02, 6-7=0:03, 7-8=1:16.</p>	3 5 21	Henkel KG a.A.	R	2006
----	--------	--	--------	----------------	---	------

W0	883426	 <p data-bbox="470 1117 1254 1324">The undermentioned mark concerns a moving trademark from which we attach 6 two-dimensional reproductions as well as one larger picture; the eight pictures are represented in ascending order (1 - 8) with the following pauses (in seconds) between the single pictures: 1-2=2:03, 2-3=2:17, 3-4=0:14, 4-5=1:15, 5-6=0:13, 6-7=2:22, 7-8=0:19.</p>	3 5 21	Henkel KG aA	R	2006
----	--------	---	--------	--------------	---	------

<p>WO</p>	<p>1049197</p>	 <p>Trademark with movement: The three blue lines turn continuously towards the left (1 turn: duration approximately 12 seconds).</p>	<p>10</p>	<p>Medical Medical AG</p>	<p>R</p>	<p>2010</p>
<p>WO</p>	<p>1049531</p>	 <p>Trademark with movement: The circle appears, the lines become clearer and a circle, completely visible, takes form, which then disappears again (flashing circle; duration: 3-4 seconds).</p>	<p>10</p>	<p>Hamilton Medical AG</p>	<p>R</p>	<p>2010</p>
<p>WO</p>	<p>1264152</p>	 <p>The mark consists of a motion mark of numerous pictures coming together to form a swirl design above the word "SEAGATE".</p>	<p>9</p>	<p>Seagate Technology LLC</p>	<p>R</p>	<p>2015</p>

W = zurückgezogen oder zurückgewiesen, withdrawn or rejected

R = eingetragen, registered

E = geprüft, examination

A = Beschwerde, Appeal

O = Widerspruch, Opposition

C = Löschung, Cancellation